

product
catalogue

TABLE OF CONTENTS

ABOUT THE COMPANY 3

CASH MANAGEMENT SYSTEM 5

Deposit machines 7

TRIO – coins recycler, banknotes dispenser, deposit machine 8

SAFES 9

Kolibr safes, safety grade S1 11

KSN wall safes, safety grade S1 14

ML furniture safes, safety grade S1 15

ML furniture safes, safety grade S2 16

SL light safes, safety grade I 19

SG office safes, safety grade II 22

GUN SAFES 26

MLB safes for long firearms, safety grade S1 27

MLB drawers for long firearms, safety grade S1 31

SLB safes for long firearms, safety grade I 32

STRONG SAFES 33

KP strong safes, safety grades II, V, VI, VIII 34

KP PRO strong safes, safety grades II, III, IV 36

KP ECB-S strong safes, safety grades II, III 41

SECURITY CABINETS FOR DOCUMENTS 46

Security cabinets for documents, without safety grade 47

MS security cabinets for documents, safety grades A,B,C 48

SD security cabinets for documents, safety grades S1, S2, 0 51

BUSINESS SOLUTIONS 54

Kolibr deposit drop safes, without safety grade 55

Kolibr deposit drop safes, safety grade S1 56

ML deposit drop safes, safety grade S1 57

KP strong safes with a deposit drop drum, safety grade II 58

SW deposit drop cashboxes, no grade 59

SL cashier safes, safety grade I 60

Multi-safe XS, safety grade S2, I 61

Electronic deposit strong safes 62

STRONGROOMS 63

ABOUT THE COMPANY

SAFETY, QUALITY, TRUST

We are the European leader in production of mechanical and mechatronic property protection systems, cash control and management systems. We distinguish ourselves from the competitors thanks to our long-term experience, own unique technical solutions used in our applications, care for high-quality complemented by a modern design.

Our products are used at the Office of the President, the Senate of Poland, as well as at courts of European monarchs. They are used by the largest Polish banks, companies, offices, as well as private houses.

We have earned the trust of 90% of Polish banks and financial institutions. Our customers, both institutional and individual, mainly appreciate us for modern products: electronic deposit devices, strong safes, safes, strong rooms, computer-controlled systems for supervision, issue, deposits, and recycling of cash.

As a confirmation for the high-quality of our product, we have been granted the NATO Commercial and Governmental Entity Code, which constitutes a distinctive feature in the NATO Codification System – NCS.

INTERNATIONAL EXPERIENCE

Konsmetal – as the only Polish company – is a member of the prestigious European Security Systems Association, an association of the largest manufacturers of passive protections in the world.



CERTIFICATES AND ATTESTATIONS

Konsmetal is the holder of the following certificates and attestations:

- NCAGE – the NATO Commercial and Government Entity code;
- IMP – Instytut Mechaniki Precyzyjnej (Poland);
- ABW – Departament Bezpieczeństwa
- Teleinformatycznego ABW (Poland);
- TÜV Nord Polska – a quality system certificate;
- ECB – the European Certification Body (Germany);
- VdS – Schadenverhütung (Germany);
- SBSC – Svensk Brand & Säkerhets Certifiering AB (Sweden);
- SP – Sveriges Provnings – och Forskningsinstitut (Sweden);
- SKAFOR – Dansk Forening for Skadeforsikring (Denmark).

AWARDS AS THE CONFIRMATION OF ACCOMPLISHMENTS

The exceptional position of products by Konsmetal is confirmed by the following awards:

- MTP Gold Medal for the Valuables Management System, awarded at SECUREX 2014 expo;
- Acanthus Aureus MTP for participation in the expo with a stand that had the most favorable features for implementation of the marketing strategy of the company, 2014;
- MTP Gold Medal for the Self-locking Anti-burglary System, awarded at SECUREX 2012 expo;
- MTP Gold Medal for Light Strong Safes, awarded at SECUREX 2010 expo;
- MTP Gold Medal for LS safes, awarded at SECUREX 2010 expo.

A MODERN PRODUCTION PLANT

Konsmetal produces its goods at a modern production plant in Nidzica. The production plant is one of the most modern facilities in the industry in Europe. The production is conducted with the use of **laser technology**.

Laser
technology

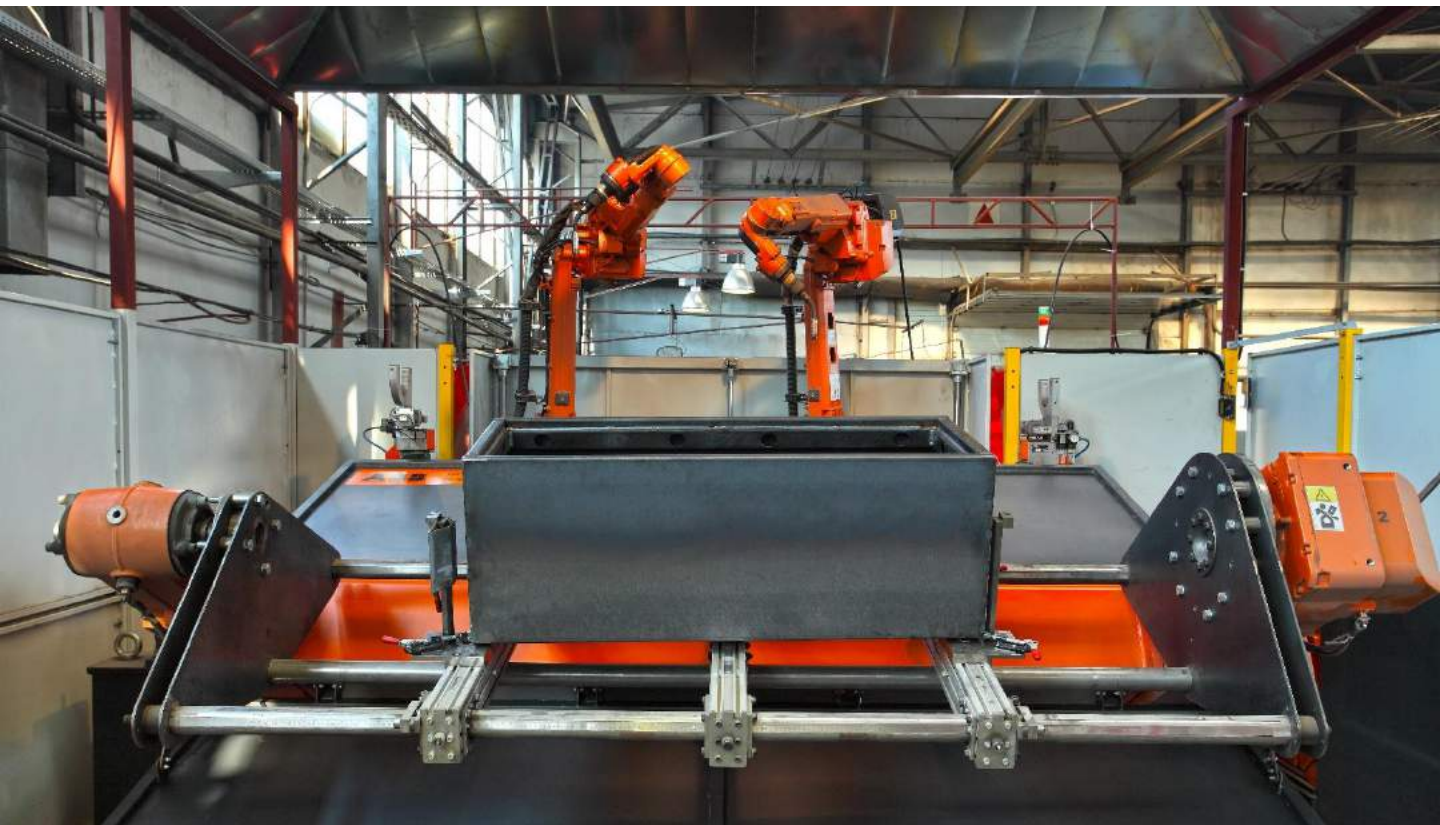



CASH MANAGEMENT SYSTEM

CASH MANAGEMENT SYSTEM

The innovative Cash Management System (CMS) was designed by Konsmetal for comprehensive management of the cash flow (coins and banknotes) in retail stores.

Our devices are suitable for depositing and withdrawing cash at the cash register, as well as at the back office of the retail store. They are combined with an application used for the ongoing control of the cash flow and remote management of devices in the system.

These devices can be integrated with:

- > POS operating in store;
- > ERP system operating in a retail chain;
- > **Bank's IT system** – the cash deposited in the device is booked online on company's bank account;
- > **CIT** – by sending an information on the status and structure of cash in devices and the need to collect the money

Possible integration scheme:

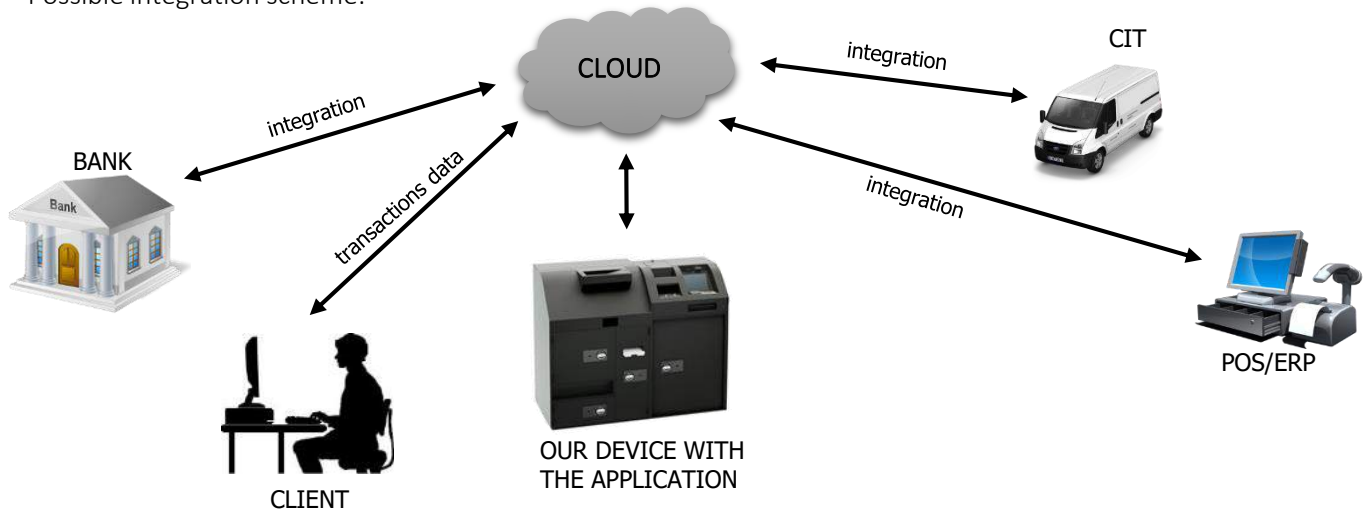

COSTS

THE REASON OF THE COST

OUR SOLUTION

the cost of money over time

cash is available on company's account a few days after the cashier deposits it from the customer

availability of funds on your bank account as soon as they are deposited – real-time booking

the cost of money transferring

CIT services

reduction of CIT transports – lower frequency of cash pick-ups

the cost of counting money

the cost of supervision of cashiers taking out and taking in money before and after their shifts, as well as taking in money during the shift and changing money (personel related costs)

personnel related costs savings – limited managerial supervision, automation in taking in and taking out money by the cashiers

other costs

the cost of mistakes or internal thefts

full control over cashier's reconciliation status – reduction of losses resulting from introducing cashier's drawn balance

DEPOSIT MACHINES

FRONT OFFICE DEVICES

This device, intended to be placed at front office, enables:

- online booking of deposited cash in cash register;
- precise reconciliation of the shift or the cashier;
- current money withdrawal from cash register and deposition in the machine;
- verification of deposited banknotes' authenticity;
- multicurrency (PLN, EUR, USD, GBP, CHF);
- receiving current information on the status and structure of cash in the store.

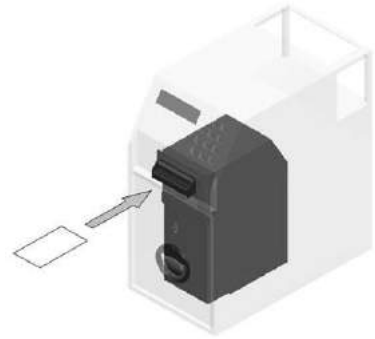

BACK OFFICE DEVICES

One device for all cashiers in a store that allows for:

- reconciliation of the cashier or the whole shift after the end of the shift;
- online booking after reconciliation of cashier's shift;
- more efficient money deposition by placing them in automatic bunch note feeder;
- elimination of the multiple cash counting process;
- limited managerial supervision in reconciliation of the cashier;
- current information on the status and structure of cash in devices and/or store.

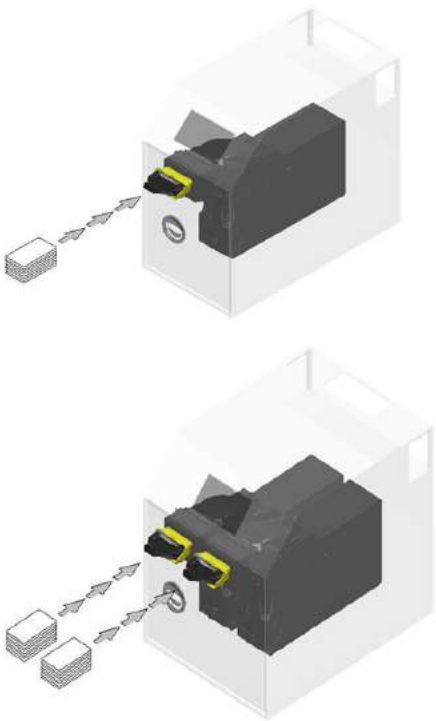

	Deposit machine with 1 cassette	Deposit machine with 2 cassettes
Capacity	900 1 200 2 200	2 x 1 200 2 x 2 200
Way of depositing	single banknote or bunch of banknotes	single banknote or bunch of banknotes
Bunch of banknotes size	50	2 x 50
Speed of receiving single banknotes	20/minute	2 x 20/minute
Speed of receiving a bunch of banknotes	40/minute	2 x 40/minute

DM with 1 cassette

DM with 2 cassettes



The TRIO set is a banknote deposit machine with coins recycler and banknote dispenser that prepares the cashier to start the shift and reconciliates them after the shift. TRIO allows for:

- online booking after reconciliation of cashier's shift;
- banknotes and coins deposition and withdrawal with the record of all transactions;
- counting the coins and banknotes both as to quantity and value;
- coins and banknotes withdrawal of a certain denominations.



Non-financial benefits of the Cash Management System:

- current information on the status and structure of cash in devices, store and/or retail chain;
- registration of all deposits and cash-related operations;
- optimizing (speeding up and simplifying) the processes of withdrawing and depositing money;
- elimination of the multiple cash counting process;
- daily reconciliation of the cashier instead of cash register;
- increase in profitability due to focusing the manager staff on key business tasks;
- safe cash storage – in certified Konsmetal devices of Cash Management System;
- elimination of the risk of entering into circulation the counterfeit notes and coins.

The reduction of cash handling process costs up to **80%**

80% reduction of cash handling process costs up to



SAFES



KONSMETAL SAFES

YOUR SAFE IS YOUR FORTRESS

Safes produced by Konsmetal are subjected to strict tests concerning resistance to burglary and have certificates that confirm their compliance with restrictive European regulations.

Tests are conducted by an independent certification body. As a part of the tests, the safe must resist various types of burglary. After a successful procedure, the safe is granted a specific resistance grade.

CERTIFICATES in individual resistance grades are granted as a part of the following standards:

- European standard EN 1143-1: Resistance to burglary, values in safety grades 0 and higher;
- European standard EN 14450: Resistance to burglary, values in safety grades S1 and S2;

GUARANTEE OF ANTI-BURGLARY PROPERTIES



Konsmetal safes are subjected to stringent tests for anti-burglary resistance.

CERTIFIED LOCKS



Konsmetal safes are equipped with certified locks of renowned manufacturers: key, code, and electronic locks.

THE HIGHEST SAFETY STANDARDS



Konsmetal safes are equipped with complex door locking mechanisms with movable and fixed bolts. The cover system applied in the construction of our products secures the bolts from being drilled through and removed.

OPTIONAL ACCESSORIES OF THE SAFE INTERIOR



A possibility of installing additional elements, i.a. caches, money insert systems, alarm systems, and shelves.

GUARANTEE OF THE HIGHEST QUALITY



Every product that leaves our production plant is compliant with regulations regarding functionality and safety of the users. We have been accredited with the ISO certificate.

SERVICING



Konsmetal owns a well-developed network for technical service and servicing that covers all the activities from assembly to maintenance.

Kolibler safes are used for general protection of valuables, i.e. money, documents, or jewelry. Their name (in Polish, 'koliber' stands for 'humming bird') derives from their size and weight – they are the smallest safes in our offer, perfect to be used at home or at the office.

- body with increased resistance to being forced
- reinforced door with protection of the bolts and the lock
- sturdy vertical bolts with a diameter of 20 mm
- drill protection for the bolts
- a special door locking mechanism that prevents the safe from being opened, even if the hinges have been cut off.
- thickness of the body 3 mm, thickness of the door 51 mm
- certificate of the Institute of Precision Mechanics in safety grade S1
- grade A key lock



Model	Outer dimensions [mm]			Inner dimensions [mm]			Weight [kg]	Capacity [l]
	H	W	D	H	W	D		
Kolibler 16 STANDARD	160	310	180	154	304	115	11	5
Kolibler 20 STANDARD	200	310	200	194	304	135	13	8
Kolibler 20 Laptop 15" STANDARD	200	490	370	194	484	305	24	29
Kolibler 26 Laptop 17" STANDARD	260	490	370	254	474	305	27	37
Kolibler 35 STANDARD	350	310	280	344	294	215	22	22
Kolibler 45 Laptop 15" STANDARD	450	400	370	444	384	305	35	52
Kolibler 45 Laptop 17" STANDARD	450	490	370	444	474	305	40	64
Kolibler 62 Laptop 17" STANDARD	620	490	370	614	474	305	50	89

anti-burglary protection level

S1 S2 0 I II III IV and higher

available colours:

light gray RAL 7035 black RAL 9005

Kolibler 16 STANDARD
Kolibler 20 Laptop 15" STANDARD
Kolibler 20 STANDARD
Kolibler 26 Laptop 17" STANDARD
Kolibler 35 STANDARD
Kolibler 45 Laptop 15" STANDARD
Kolibler 45 Laptop 17" STANDARD
Kolibler 62 Laptop 17" STANDARD

In addition to STANDARD LINE this version has been equipped with electronic lock and vertical bolts.

- body with increased resistance to being forced
- reinforced door with protection of the bolts and the lock
- sturdy **vertical and horizontal bolts** with a diameter of 20 mm
- drill protection for the bolts
- a special door locking mechanism that prevents the safe from being opened, even if the hinges have been cut off.
- thickness of the body 3 mm, thickness of the door 51 mm
- certificate of the Institute of Precision Mechanics in safety grade S1
- **grade B electronic lock**



Model	Outer dimensions [mm]			Inner dimensions [mm]			Weight [kg]	Capacity [l]
	H	W	D	H	W	D		
Koliber 20 Laptop 15" STRONG	200	490	370	194	484	305	24	29
Koliber 26 Laptop 17" STRONG	260	490	370	254	474	305	27	37
Koliber 45 Laptop 15" STRONG	450	400	370	444	384	305	35	52
Koliber 45 Laptop 17" STRONG	450	490	370	444	474	305	40	64
Koliber 62 Laptop 17" STRONG	620	490	370	614	474	305	50	89

anti-burglary protection level

available colours:

light gray RAL 7035 black RAL 9005

S1 S2 0 I II III IV and higher

Koliber 20 Laptop 15" STRONG

Koliber 26 Laptop 17" STRONG

Koliber 45 Laptop 15" STRONG

Koliber 45 Laptop 17" STRONG

Koliber 62 Laptop 17" STRONG

This line has special customization package with interior of the safe finished with a soft flocked fabric, three-armed chrome/gold knob and a decorative chrome/gold signboard. It is also equipped with electronic lock grade B.

- body with increased resistance to being forced
- reinforced door with protection of the bolts and the lock
- sturdy vertical and horizontal bolts in chrome/gold color with a diameter of 20 mm
- drill protection for the bolts
- a special door locking mechanism that prevents the safe from being opened, even if the hinges have been cut off.
- thickness of the body 3 mm, thickness of the door 51 mm
- certificate of the Institute of Precision Mechanics in safety grade S1
- grade B electronic lock
- customization package: interior of the safe finished with a soft flocked fabric, three-armed chrome/gold knob, and a decorative chrome/gold signboard
- high-gloss paint coating



Model	Outer dimensions [mm]			Inner dimensions [mm]			Weight [kg]	Capacity [l]
	H	W	D	H	W	D		
Koliber 20 Laptop 15" PREMIUM	200	490	370	168	484	305	24	25
Koliber 26 Laptop 17" PREMIUM	260	490	370	228	474	305	27	33
Koliber 45 Laptop 15" PREMIUM	450	400	370	418	384	305	35	49
Koliber 45 Laptop 17" PREMIUM	450	490	370	418	474	305	40	60
Koliber 62 Laptop 17" PREMIUM	620	490	370	588	474	305	50	85

anti-burglary protection level

S1 S2 0 I II III IV and higher

available colours:

high-gloss paint coating with any RAL colour

Koliber 20 Laptop 15" PREMIUM

Koliber 26 Laptop 17" PREMIUM

Koliber 45 Laptop 15" PREMIUM

Koliber 45 Laptop 17" PREMIUM

Koliber 62 Laptop 17" PREMIUM

KSN WALL SAFES

with S1 safety grade

KSN wall safe is a safe that, thanks to each flat design of the door, can be installed out of people's sight, e.g. behind a painting. It can be easily installed in a wall and used both at home and at the office.

- body with increased resistance to being forced
- reinforced door with protection of the bolts and the lock
- sturdy bolts with a diameter of 20 mm
- drill protection for the bolts
- a special door locking mechanism that prevents the safe from being opened, even if the hinges have been cut off.
- thickness of the body 3 mm, thickness of the door 51 mm
- certificate of the Institute of Precision Mechanics in safety grade S1
- compliance with standard PN-EN 14450 regarding storage of valuables in safety grade S1
- grade A key lock
- **specially-designed fixtures that allow mounting the safe in a wall**



Model	Outer dimensions [mm]			Inner dimensions [mm]			Weight [kg]	Capacity [l]
	H	W	D	H	W	D		
KSN 20 STANDARD	282	392	236	194	304	135	19	8
KSN 26 Laptop 17" STANDARD	342	572	406	254	474	305	36	37
KSN 35 STANDARD	432	392	316	344	294	215	30	29
KSN 45 Laptop 17" STANDARD	532	572	406	444	474	305	52	64

anti-burglary protection level

S1 S2 0 I II III IV and higher

available colours:

- light gray RAL 7035
- black RAL 9005

KSN 20

KSN 26 Laptop 17"

KSN 35

KSN 45 Laptop 17"

ML FURNITURE SAFES

with S1 safety grade

ML safe is a safe that, contrary to standard versions of safes, has special security element in form of additional bolts and patented anti-burglary structure. It will work perfectly for storage of jewelry, weapons and ammunition, documents, and other valuables.

- an anti-burglary self-locking system that increases the resistance of the safe to burglary
- an anti-burglary frame that efficiently protects against crowbars
- a four-sided bolting system of the door (vertical, horizontal bolts and a fixed bolt) with a diameter of 20 mm
- thickness of the body 3 mm, thickness of the door 83 mm
- possibility of storing guns and ammunition
- certificate of the Institute of Precision Mechanics in safety grade S1
- compliance with standard PN-EN 14450 regarding storage of valuables in safety grade S1
- compliant with the following requirements:
 - The Council of Ministers Regulation dated 29.05.2012 on storage of classified documents TYPE 3
 - Regulation of the Polish Ministry of Interior and Administration dated 11.12.2013 concerning storage of guns and ammunition
 - Regulation of the Polish Ministry of Interior and Administration dated 26.08.2014 on storage of guns and ammunition
- grade A key lock



Model	Outer dimensions [mm]			Inner dimensions [mm]			Weight [kg]	Capacity [l]
	H	W	D	H	W	D		
ML 30	300	400	400	294	394	285	33	33
ML 45	450	400	460	444	394	340	47	59
ML 67	670	400	460	664	394	340	60	89
ML 100	1000	490	460	994	484	340	90	164

anti-burglary protection level

S1 S2 0 I II III IV and higher

available colours:

- light gray RAL 7035
- black RAL 9005

ML 30 ML 45 ML 67 ML 100

ML FURNITURE SAFES

with S2 safety grade

ML safe is a safe that, contrary to standard versions of safes, has special security element in form of additional bolts and patented anti-burglary structure. Moreover, safety grade S2 guarantees the application of a reinforced structure resistant to being forced open.

- a multi-layered structure with high resistance to burglary
- a four-sided bolting system of the door (vertical, horizontal bolts and a fixed bolt with a diameter of 20 mm) with a sturdy cover of the bolts and the lock
- drill protection for the lock
- thickness of the body 45-50 mm, thickness of the door 83 mm
- certificate of the Institute of Precision Mechanics in safety grade S2
- compliance with standard PN-EN 14450 regarding storage of valuables in safety grade S2
- compliant with the following requirements:
 - The Council of Ministers Regulation dated 29.05.2012 on storage of classified documents TYPE 3
 - Regulation of the Polish Ministry of Interior and Administration dated 11.12.2013 concerning storage of guns and ammunition
 - Regulation of the Polish Ministry of Interior and Administration dated 26.08.2014 on storage of guns and ammunition
- grade A key lock



Model	Outer dimensions [mm]			Inner dimensions [mm]			Weight [kg]	Capacity [l]
	H	W	D	H	W	D		
ML 30 S2 STANDARD	300	400	400	200	300	240	40	14
ML 45 S2 STANDARD	450	400	460	350	300	300	57	32
ML 67 S2 STANDARD	670	400	460	570	300	300	74	51
ML 100 S2 STANDARD	1000	490	460	900	390	300	110	105

anti-burglary protection level

S1 **S2** 0 I II III IV and higher

available colours:

- light gray RAL 7035
- black RAL 9005

ML 30 STANDARD

ML 45 STANDARD

ML 67 STANDARD

ML 100 STANDARD

ML FURNITURE SAFES

with S2 safety grade

STRONG LINE has been equipped with electronic lock grade B and has a characteristic finish for the STRONG line, i.e. a round metal handle and a signboard made of polished stainless steel.

- a multi-layered structure with high resistance to burglary
- a four-sided bolting system of the door (vertical, horizontal bolts and a fixed bolt with a diameter of 20 mm) with a sturdy cover of the bolts and the lock
- drill protection for the lock
- thickness of the body 45-50 mm, thickness of the door 83 mm
- certificate of the Institute of Precision Mechanics in safety grade S2
- compliance with standard PN-EN 14450 regarding storage of valuables in safety grade S2
- compliant with the following requirements:
 - The Council of Ministers Regulation dated 29.05.2012 on storage of classified documents TYPE 3
 - Regulation of the Polish Ministry of Interior and Administration dated 11.12.2013 concerning storage of guns and ammunition
 - Regulation of the Polish Ministry of Interior and Administration dated 26.08.2014 on storage of guns and ammunition
- **grade B electronic lock**



Model	Outer dimensions [mm]			Inner dimensions [mm]			Weight [kg]	Capacity [l]
	H	W	D	H	W	D		
ML 30 S2 STRONG	300	400	400	200	300	240	40	14
ML 45 S2 STRONG	450	400	460	350	300	300	57	32
ML 67 S2 STRONG	670	400	460	570	300	300	74	51
ML 100 S2 STRONG	1000	490	460	900	390	300	110	105

anti-burglary protection level

S1 **S2** 0 I II III IV and higher

available colours:

- light gray RAL 7035
- black RAL 9005

ML 30 STRONG

ML 45 STRONG

ML 67 STRONG

ML 100 STRONG

ML FURNITURE SAFES

with S2 safety grade

PREMIUM LINE is our special offer for those who care not only about the safety, but also about unique design of their safe. It has a special customization package with interior of the safe finished with a soft flocked fabric, three-armed chrome/gold knob, and a decorative chrome/gold signboard, as well as a high-gloss paint coating.

- a multi-layered structure with high resistance to burglary
- a four-sided bolting system of the door (vertical, horizontal bolts and a fixed bolt with a diameter of 20 mm) with a sturdy chrome/gold cover of the bolts and the lock
- drill protection for the lock
- thickness of the body 45-50 mm, thickness of the door 83 mm
- certificate of the Institute of Precision Mechanics in safety grade S2
- compliance with standard PN-EN 14450 regarding storage of valuables in safety grade S2
- compliant with the following requirements:
 - The Council of Ministers Regulation dated 29.05.2012 on storage of classified documents TYPE 3
 - Regulation of the Polish Ministry of Interior and Administration dated 11.12.2013 concerning storage of guns and ammunition
 - Regulation of the Polish Ministry of Interior and Administration dated 26.08.2014 on storage of guns and ammunition
- grade B electronic lock
- customization package: interior of the safe finished with a soft flocked fabric, three-armed chrome/gold knob, and a decorative chrome/gold signboard, high-gloss paint coating



Model	Outer dimensions [mm]			Inner dimensions [mm]			Weight [kg]	Capacity [l]
	H	W	D	H	W	D		
ML 30 S2 PREMIUM	300	400	400	190	300	230	40	13
ML 45 S2 PREMIUM	450	400	460	340	300	290	57	30
ML 67 S2 PREMIUM	670	400	460	560	300	290	74	49
ML 100 S2 PREMIUM	1000	490	460	890	390	290	110	101

anti-burglary protection level

S1 **S2** 0 I II III IV and higher

available colours:

high-gloss paint coating with any RAL colour

ML 30 PREMIUM

ML 45 PREMIUM

ML 67 PREMIUM

ML 100 PREMIUM



Thanks to the elegant finish and extended structure of the door and the body, SL Safe can be considered as the synonym for high-quality and safety. It can be used for storage of money, jewelry, documents, or weapons.

- a strong two-layer structure of the body with an additional ceramic filler that prevents it from being destroyed
- an additional system of fuses locking the safe upon a burglary attempt
- vertical and horizontal bolts with a diameter of 20 mm
- an additional system that protects the lock mechanism against drilling
- thickness of the body 50 mm, thickness of the door 86 mm
- certificate of the Institute of Precision Mechanics in safety grade I
- grade A key lock



Model	Outer dimensions [mm]			Inner dimensions [mm]			Weight [kg]	Capacity [l]
	H	W	D	H	W	D		
SL 30 STANDARD	300	490	460	200	390	300	66	23
SL 45 STANDARD	450	490	460	350	390	300	87	41
SL 67 STANDARD	670	490	460	570	390	300	115	67
SL 85 STANDARD	850	490	460	750	390	300	137	88
SL 100 STANDARD	1000	490	460	900	390	300	157	105
SL 120 STANDARD	1200	490	460	1100	390	300	180	129
SL 150 STANDARD	1500	490	460	1400	390	300	220	164
SLP 67 STANDARD	670	600	500	570	500	340	138	97
SLP 85 STANDARD	850	600	500	750	500	340	160	128
SLP 100 STANDARD	1000	600	500	900	500	340	185	153
SLP 120 STANDARD	1200	600	500	1100	500	340	215	187
SLP 150 STANDARD	1500	600	500	1400	500	340	260	238

anti-burglary protection level

S1 S2 0 I II III IV and higher

available colours:

light gray
RAL 7035

black
RAL 9005

STRONG LINE has been equipped with grade B electronic lock. Thanks to the elegant finish and extended structure of the door and the body, SL Safe can be considered as the synonym for high-quality and safety. It can be used for storage of money, jewelry, documents, or weapons.

- an extensive construction of the body and the door made of the highest-quality metal signboard sheet, preventing it from being destroyed
- a complex system of horizontal and vertical bolts with a diameter of 30 mm
- an additional system of fuses locking the safe upon a burglary attempt
- inner lock cover
- thickness of the body 50 mm, **thickness of the door 91 mm**
- certificate of the Institute of Precision Mechanics in safety grade I
- compliance with standard PN-EN 1143-1 regarding storage of valuables in safety grade I
- compliant with the following requirements:
 - Regulation of the Polish Ministry of Interior and Administration dated 11.12.2013 concerning storage of guns and ammunition
 - Regulation of the Polish Ministry of Interior and Administration dated 26.08.2014 on storage of guns and ammunition
- **grade B electronic lock**



Model	Outer dimensions [mm]			Inner dimensions [mm]			Weight [kg]	Capacity [l]
	H	W	D	H	W	D		
SL 30 STRONG	300	490	460	200	390	300	66	23
SL 45 STRONG	450	490	460	350	390	300	87	41
SL 67 STRONG	670	490	460	570	390	300	115	67
SL 100 STRONG	1000	490	460	900	390	300	157	105
SL 150 STRONG	1500	490	460	1400	390	300	220	164

anti-burglary protection level

S1 S2 0 I II III IV and higher

available colours:

light gray
RAL 7035

black
RAL 9005

SL 30
STRONG

SL 45
STRONG

SL 67
STRONG

SL 100
STRONG

SL 150
STRONG

PREMIUM LINE has a special design thanks to the high-gloss paint coating and a customization package. Because of the elegant finish and extended structure of the door and the body, SL Safe PREMIUM can be considered as the synonym for high-quality and safety. It can be used for storage of money, jewelry, documents or weapons.

- an extensive construction of the body and the door made of the highest-quality metal signboard sheet, preventing it from being destroyed
- a complex system of horizontal and vertical bolts with a diameter of 30 mm
- an additional system of fuses locking the safe upon a burglary attempt
- inner lock cover
- thickness of the body 50 mm, thickness of the door 91 mm
- certificate of the Institute of Precision Mechanics in safety grade I
- compliance with standard PN-EN 1143-1 regarding storage of valuables in safety grade I
- compliant with the following requirements:
 - Regulation of the Polish Ministry of Interior and Administration dated 11.12.2013 concerning storage of guns and ammunition
 - Regulation of the Polish Ministry of Interior and Administration dated 26.08.2014 on storage of guns and ammunition
- **grade B electronic lock**
- **customization package: interior of the safe finished with a soft flocked fabric, three-armed chrome/gold knob, and a decorative chrome/gold signboard, high-gloss paint coating**



Model	Outer dimensions [mm]			Inner dimensions [mm]			Weight [kg]	Capacity [l]
	H	W	D	H	W	D		
SL 30 PREMIUM	300	490	460	190	380	300	66	22
SL 45 PREMIUM	450	490	460	340	380	300	87	39
SL 67 PREMIUM	670	490	460	560	380	300	115	64
SL 100 PREMIUM	1000	490	460	890	380	300	157	101
SL 150 PREMIUM	1500	490	460	1390	380	300	220	158

anti-burglary protection level

S1 S2 0 I II III IV and higher

available colours:

high-gloss paint coating with any RAL colour

SL 30 PREMIUM

SL 45 PREMIUM

SL 67 PREMIUM

SL 100 PREMIUM

SL 150 PREMIUM

This is our strongest office safe, which combines high-quality structure with the best anti-burglary solutions. It is dedicated for storage of cash, securities, documents, and other valuables.

- the strongest multi-layered structure with a special filling that successfully prevents from breaking in to the safe by using a grinder and a crowbar
- a four-sided bolting system of the door (vertical, horizontal bolts and a fixed bolt with a diameter of 30 mm)
- an intermediate blocking system that covers the lock during an attack on the bolts
- a system protecting the lock against drilling
- a fireproof threshold system
- **thickness of the body 80 mm, thickness of the door 143 mm**
- certificate of the Institute of Precision Mechanics in safety grade II
- compliance with standard PN-EN 1143-1 regarding storage of valuables in safety grade II
- compliance with requirements of the Regulation of the Polish Ministry of Interior and Administration dated 26.08.2014 on storage of guns and ammunition
- grade A key lock



Model	Outer dimensions [mm]			Inner dimensions [mm]			Weight [kg]	Capacity [l]
	H	W	D	H	W	D		
SG 62 STANDARD	620	580	570	460	420	340	157	66
SG 100 STANDARD	1000	580	570	840	420	340	257	120
SG 120 STANDARD	1200	580	570	1040	420	340	297	149
SG 150 STANDARD	1500	580	570	1340	420	340	388	191
SG 180 STANDARD	1800	580	570	1640	420	340	442	234

anti-burglary protection level

S1 S2 0 I **II** III IV and higher

available colours:

- light gray RAL 7035
- black RAL 9005

SG 62 STANDARD

SG 100 STANDARD

SG 120 STANDARD

SG 150 STANDARD

SG 150 STANDARD

SG office safe in STRONG LINE was equipped with grade B electronic lock instead of a key lock.

- the strongest multi-layered structure with a special filling that successfully prevents from breaking in to the safe by using a grinder and a crowbar
- a four-sided bolting system of the door (vertical, horizontal bolts and a fixed bolt with a diameter of 30 mm)
- an intermediate blocking system that covers the lock during an attack on the bolts
- a system protecting the lock against drilling
- a fireproof threshold system
- **thickness of the body 80 mm, thickness of the door 143 mm**
- certificate of the Institute of Precision Mechanics in safety grade II
- compliance with standard PN-EN 1143-1 regarding storage of valuables in safety grade II
- compliant with requirements of the Regulation of the Polish Ministry of Interior and Administration dated 26.08.2014 on storage of guns and ammunition
- **grade B electronic lock**



Model	Outer dimensions [mm]			Inner dimensions [mm]			Weight [kg]	Capacity [l]
	H	W	D	H	W	D		
SG 62 STRONG	620	580	570	460	420	340	157	66
SG 100 STRONG	1000	580	570	840	420	340	257	120
SG 120 STRONG	1200	580	570	1040	420	340	297	149
SG 150 STRONG	1500	580	570	1340	420	340	388	191
SG 180 STRONG	1800	580	570	1640	420	340	442	234

anti-burglary protection level

S1 S2 0 I **II** III IV and higher

available colours:

- light gray RAL 7035
- black RAL 9005

SG 62 STRONG

SG 100 STRONG

SG 120 STRONG

SG 150 STRONG

SG 150 STRONG

PREMIUM LINE has a special design thanks to the high-gloss paint coating and a customization package in form of interior finished with a soft flocked fabric, three-armed chrome/gold knob, and a decorative chrome/gold signboard.

- the strongest multi-layered structure with a special filling that successfully prevents from breaking in to the safe by using a grinder and a crowbar
- a four-sided bolting system of the door (chrome/gold horizontal, vertical bolts and a fixed chrome/gold bolt with a diameter of 30 mm)
- an intermediate blocking system that covers the lock during an attack on the bolts
- a system protecting the lock against drilling
- a fireproof threshold system
- thickness of the body 80 mm, thickness of the door 143 mm
- certificate of the Institute of Precision Mechanics in safety grade II
- compliance with standard PN-EN 1143-1 regarding storage of valuables in safety grade II
- compliant with requirements of the Regulation of the Polish Ministry of Interior and Administration dated 26.08.2014 on storage of guns and ammunition
- grade B electronic lock**
- high-gloss paint coating**
- customization package: interior of the safe finished with a soft flocked fabric, three-armed chrome/gold knob, and a decorative chrome/gold signboard**



Model	Outer dimensions [mm]			Inner dimensions [mm]			Weight [kg]	Capacity [l]
	H	W	D	H	W	D		
SG 62 PREMIUM	620	580	570	450	420	330	157	62
SG 100 PREMIUM	1000	580	570	830	420	330	257	115
SG 120 PREMIUM	1200	580	570	1030	420	330	297	143
SG 150 PREMIUM	1500	580	570	1330	420	330	388	184
SG 180 PREMIUM	1800	580	570	1630	420	330	442	226

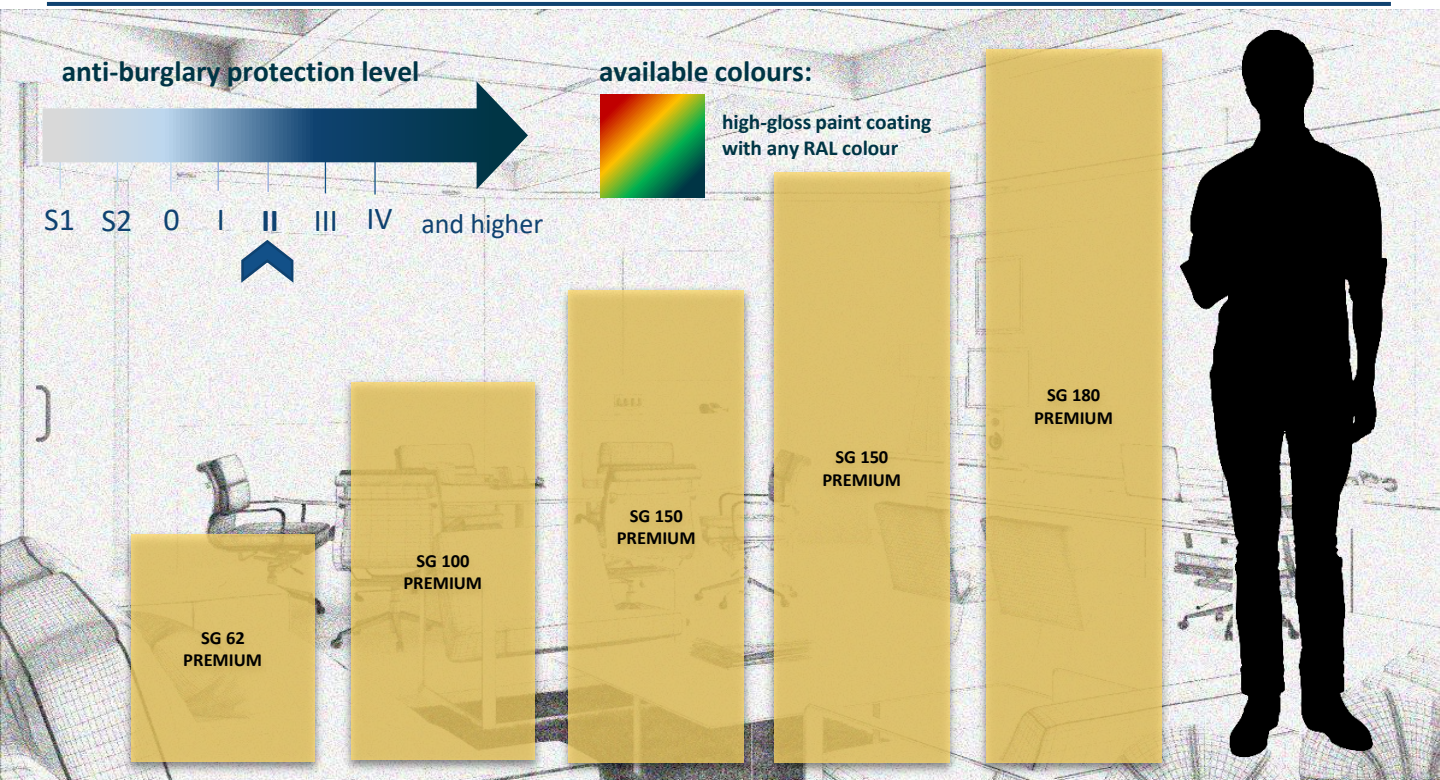

To make your safe more unique we prepared a special LUX LINE dedicated to satisfy your requirements concerning its safety and look.

- the strongest multi-layered structure with a special filling that successfully prevents from breaking in to the safe by using a grinder and a crowbar
- a four-sided bolting system of the door (chrome/gold horizontal, vertical bolts and a fixed chrome/gold bolt with a diameter of 30 mm)
- an intermediate blocking system that covers the lock during an attack on the bolts
- a system protecting the lock against drilling
- a fireproof threshold system
- thickness of the body 80 mm, thickness of the door 143 mm
- certificate of the Institute of Precision Mechanics in safety grade II
- compliance with standard PN-EN 1143-1 regarding storage of valuables in safety grade II
- compliant with requirements of the Regulation of the Polish Ministry of Interior and Administration dated 26.08.2014 on storage of guns and ammunition
- grade B electronic lock
- customization package: interior of the safe finished with a soft flocked fabric, three-armed chrome/gold knob, and a decorative chrome/gold signboard, high-quality furniture insert with drawers, rotating shelves, and LED backlighting, high-gloss paint coating



Model	Outer dimensions [mm]			Inner dimensions [mm]			Weight [kg]	Capacity [l]
	H	W	D	H	W	D		
SG 62 LUX	620	580	570	460	420	340	157	66
SG 100 LUX	1000	580	570	840	420	340	257	120
SG 120 LUX	1200	580	570	1040	420	340	297	149
SG 150 LUX	1500	580	570	1340	420	340	388	191
SG 180 LUX	1800	580	570	1640	420	340	442	234

anti-burglary protection level

S1 S2 0 I **II** III IV and higher

available colours:

high-gloss paint coating with any RAL colour



GUN SAFES ➤



Make sure that your weapons are safe. MLB safe for long firearms is used for proper protection and storage of firearms. It is required by law, as well as a basic safety rule the application of which helps to avoid problems related to unauthorized access to guns.

- a special system of anti-burglary thresholds that **increases the protection** against crowbars and theft of weapons by **one hundred times**
- a sturdy single-layer construction of the body and the door
- sturdy bolts with a diameter of 20 mm
- thickness of the body 3 mm, thickness of the door 64 mm
- in some models, jewel boxes have an additional key lock
- certificate of the Institute of Precision Mechanics in safety grade S1
- compliance with standard PN-EN 14450 in safety grade S1
- compliant with the following requirements:
 - Regulation of the Polish Ministry of Interior and Administration dated 11.12.2013 concerning storage of guns and ammunition
 - Regulation of the Polish Ministry of Interior and Administration dated 26.08.2014 on storage of guns and ammunition
- grade A key lock



Model	Outer dimensions [mm]			Inner dimensions [mm]			Weight [kg]	Capacity [l]
	H	W	D	H	W	D		
MLB 125/3 STANDARD	1250	240	350	1244	234	270	53	79
MLB 125/4+4 STANDARD	1250	500	350	1244	494	250	78	154
MLB 125P/4+4 STANDARD	1250	500	350	1244	494	250	82	154
MLB 125D/4 STANDARD	1250	500	350	1244	494	250	84	154
MLB 150D/4+4 STANDARD	1450	500	350	1444	494	250	95	178
MLB 150P/3 STANDARD	1450	240	350	1444	234	275	62	93
MLB 150P/5 STANDARD	1450	300	350	1444	294	268	70	114
MLB 150S/6 STANDARD	1450	400	400	1444	394	318	87	181
MLB 150D/6+4 STANDARD	1450	600	400	1444	594	318	118	273
MLB 150S/10 STANDARD	1450	600	400	1444	594	318	113	273
MLB 150D/10+4 STANDARD	1450	800	400	1444	794	318	141	365
MLB 150S/14 STANDARD	1450	800	400	1444	794	318	136	365
MLB corner STANDARD	1500	600	453	1494	594	350	100	180
MLB wall STANDARD	1500	600	125	1494	594	105	80	93

anti-burglary protection level

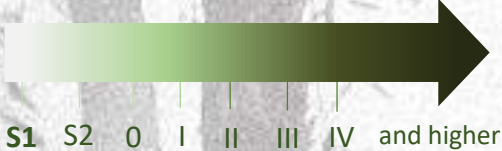

available colours:

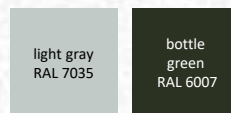

MLB gun safes in STRONG line are distinguished by an innovative door locking system using a toothed bar. The STRONG line is equipped with a class B electronic lock. Some models have additionally locked locks.

- a special system of anti-burglary thresholds that **increases the protection** against crowbars and theft of weapons by **one hundred times**
- a sturdy single-layer construction of the body and the door
- **an innovative bolting system with the use of a toothed bar**
- thickness of the body 3 mm, thickness of the door 64 mm
- in some models, jewel boxes have an additional key lock
- certificate of the Institute of Precision Mechanics in safety grade S1
- compliance with standard PN-EN 14450 in safety grade S1
- compliant with the following requirements:
 - Regulation of the Polish Ministry of Interior and Administration dated 11.12.2013 concerning storage of guns and ammunition
 - Regulation of the Polish Ministry of Interior and Administration dated 26.08.2014 on storage of guns and ammunition
- **grade B electronic lock**

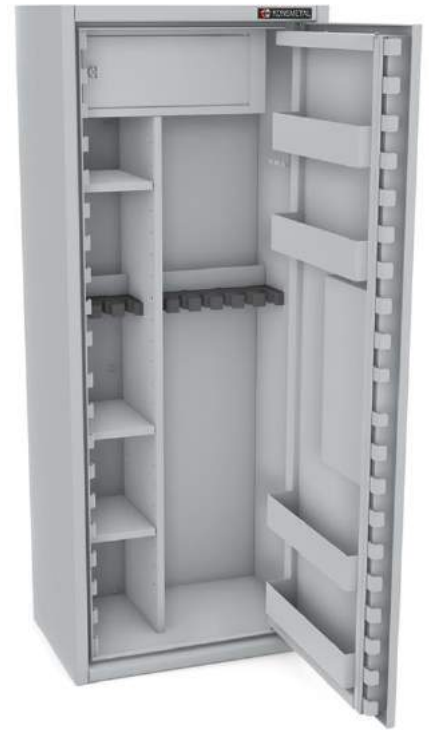

Model	Outer dimensions [mm]			Inner dimensions [mm]			Weight [kg]	Capacity [l]
	H	W	D	H	W	D		
MLB 150S/6 STRONG	1450	400	400	1405	375	280	135	148
MLB 150D/6 STRONG	1450	600	400	1405	575	290	155	234
MLB 150S/10 STRONG	1450	600	400	1405	575	290	155	234
MLB 150D/6+4 STRONG	1450	800	400	1405	775	290	185	316
MLB 150S/14 STRONG	1450	800	400	1405	775	290	185	316

anti-burglary protection level

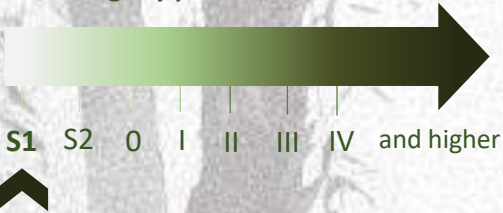

available colours:

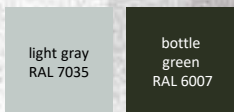

MLB GUN SAFES

with S1 safety grade

The PREMIUM line of MLB gun safes is distinguished by its stylization package: interior covered with flock, three-armed chrome/gold knob and the decorative sign in gold or chrome. The bottom of the safe was filled with a sponge that protects the rifle butts. MLB safes in the PREMIUM line are covered with a high-gloss paint coating. Safes are equipped with a class B electronic lock.

- a special system of anti-burglary thresholds that **increases the protection** against crowbars and theft of weapons by **one hundred times**
- a sturdy single-layer construction of the body and the door
- **an innovative bolting system with the use of a toothed bar**
- thickness of the body 3 mm, thickness of the door 64 mm
- in some models, jewel boxes have an additional key lock
- certificate of the Institute of Precision Mechanics in safety grade S1
- compliance with standard PN-EN 14450 in safety grade S1
- compliant with the following requirements:
 - Regulation of the Polish Ministry of Interior and Administration dated 11.12.2013 concerning storage of guns and ammunition
 - Regulation of the Polish Ministry of Interior and Administration dated 26.08.2014 on storage of guns and ammunition
- **grade B electronic lock**
- **customization package:** interior of the safe finished with a soft flocked fabric, three-armed chrome/gold knob, and a decorative chrome/gold signboard, high-gloss paint coating
- **bottom of the cabinet is secured with a special sponge that protects butts of rifles**



Model	Outer dimensions [mm]			Inner dimensions [mm]			Weight [kg]	Capacity [l]
	H	W	D	H	W	D		
MLB 150S/6 PREMIUM	1450	400	400	1405	375	280	135	148
MLB 150D/6 PREMIUM	1450	600	400	1405	575	290	155	234
MLB 150S/10 PREMIUM	1450	600	400	1405	575	290	155	234
MLB 150D/6+4 PREMIUM	1450	800	400	1405	775	290	185	316
MLB 150S/14 PREMIUM	1450	800	400	1405	775	290	185	316

anti-burglary protection level

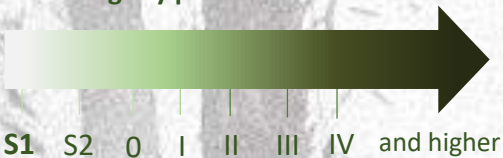

available colours:



high-gloss paint coating with any RAL colour

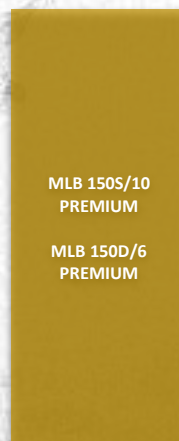
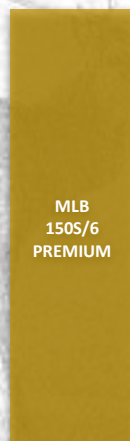

MLB GUN SAFES

with S1 safety grade

LUX line of MLB safes is a unique proposition which we each time adapt to the individual needs of the client. It has been retrofitted with a bullet-proof glazed door, anti-burglary window and additionally lockers.

- a special system of anti-burglary thresholds that **increases the protection** against crowbars and theft of weapons by **one hundred times**
- a sturdy one-layer construction of the body and the door
- **a sturdy bolt system**
- thickness of the body 3 mm, thickness of the door 64 mm
- certificate of the Institute of Precision Mechanics in safety grade S1
- compliance with standard PN-EN 14450 in safety grade S1
- compliant with the following requirements:
 - Regulation of the Polish Ministry of Interior and Administration dated 11.12.2013 concerning storage of guns and ammunition
 - Regulation of the Polish Ministry of Interior and Administration dated 26.08.2014 on storage of guns and ammunition
- **product offered in two variants: high-gloss paint coating or wooden structure coating**
- **possibility of adjusting the product to the individual needs of every customer**
- **glazed door with a bulletproof and anti-burglary pane and an exclusive development of the inside: flocked fabric inside**



Model	Outer dimensions [mm]			Inner dimensions [mm]			Weight [kg]	Capacity [l]
	H	W	D	H	W	D		
MLB LUX	1825	840	480	1335	745	300	330	298

anti-burglary protection level

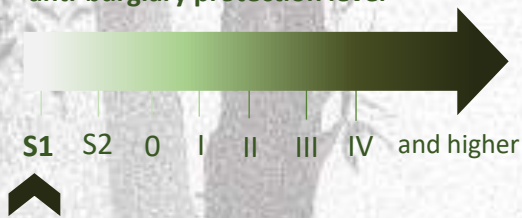

available colours:



high-gloss paint coating with any RAL colour



MLB GUN DRAWERS

with S1 safety grade

An alternative solution for people who do not have enough space for a standard safe for long firearms. Our drawer can be installed under a bed or in a closet. It is a very useful and discrete solution. Drawers are available in two sizes: 80 and 135 cm in width and can hold two long firearms.

- a sturdy single-layer construction
- a special system of anti-burglary thresholds that **increases the protection** against crowbars and theft of weapons by **one hundred times**
- thickness of the body 3 mm, thickness of the door 60 mm
- certificate of the Institute of Precision Mechanics in safety grade S1
- compliance with standard PN-EN 14450 in safety grade S1
- compliant with the following requirements:
 - Regulation of the Polish Ministry of Interior and Administration dated 11.12.2013 concerning storage of guns and ammunition
 - Regulation of the Polish Ministry of Interior and Administration dated 26.08.2014 on storage of guns and ammunition
- grade A key lock

Model	Outer dimensions [mm]			Inner dimensions [mm]			Weight [kg]	Capacity [l]
	H	W	D	H	W	D		
MLB drawer 80	160	800	500	95	690	390	50	26
MLB drawer 135	160	1350	500	95	1240	390	77	46

available colours:

light gray
RAL 7035

bottle
green
RAL 6007



SLB GUN SAFES

with I safety grade



For more guns or when there is a higher risk of unauthorized access to guns, we recommend the purchase of a reinforced safe that will secure guns and ammunition. Thanks to its quality, the SLB safe for long firearms provides the highest-level security and protection for the stored guns.

- a sturdier multi-layer construction of the body and the door
- **thickness of the body 45-50 mm, thickness of the door 86 mm**
- a patented anti-burglary frame that stiffens the whole construction and prevents an easy use of a crowbar
- depending on the model, there are available properly adjusted weapon holders, holders for cleaning rods, shelves
- a possibility of dismantling the compartment and adjust the height of weapon holders
- certificate of storage of valuables under supervision in compliance with the European standard PN-EN 1143-1:2012, **safety grade I**
- compliant with requirements of the Regulation of the Polish Ministry of Interior and Administration dated 26.08.2014 on storage, carrying, and registry of guns and ammunition
- grade A key lock



Model	Outer dimensions [mm]			Inner dimensions [mm]			Weight [kg]	Capacity [l]
	H	W	D	H	W	D		
SLB 150/3+3	1500	490	460	1400	390	300	225	164
SLB 150C/3+3	1500	490	460	1400	390	300	225	164
SLB 150P/2+2	1500	600	460	1400	500	300	225	210
SLB 150/5+5	1500	700	460	1400	600	300	285	252
SLB 150C/5+5	1500	700	460	1400	600	300	285	252
SLB 150P/3+3	1500	700	460	1400	600	300	285	252
SLB 150/7+7	1500	900	460	1400	800	300	340	336
SLB 150C/7+7	1500	900	460	1400	800	300	340	336
SLB 150P/4+4	1500	900	460	1400	800	300	340	336

anti-burglary protection level

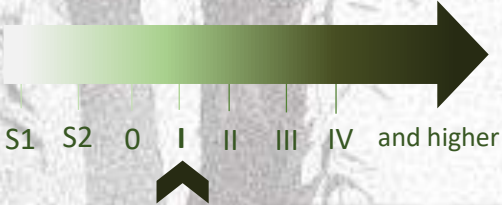

available colours:

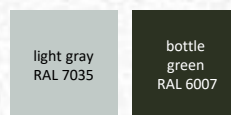

SLB 150/3+3 SLB 150C/3+3	SLB 150P/2+2	SLB 150/5+5 SLB 150C/5+5 SLB 150P/3+3	SLB 150/7+7 SLB 150C/7+7 SLB 150P/4+4
-----------------------------	--------------	---	---



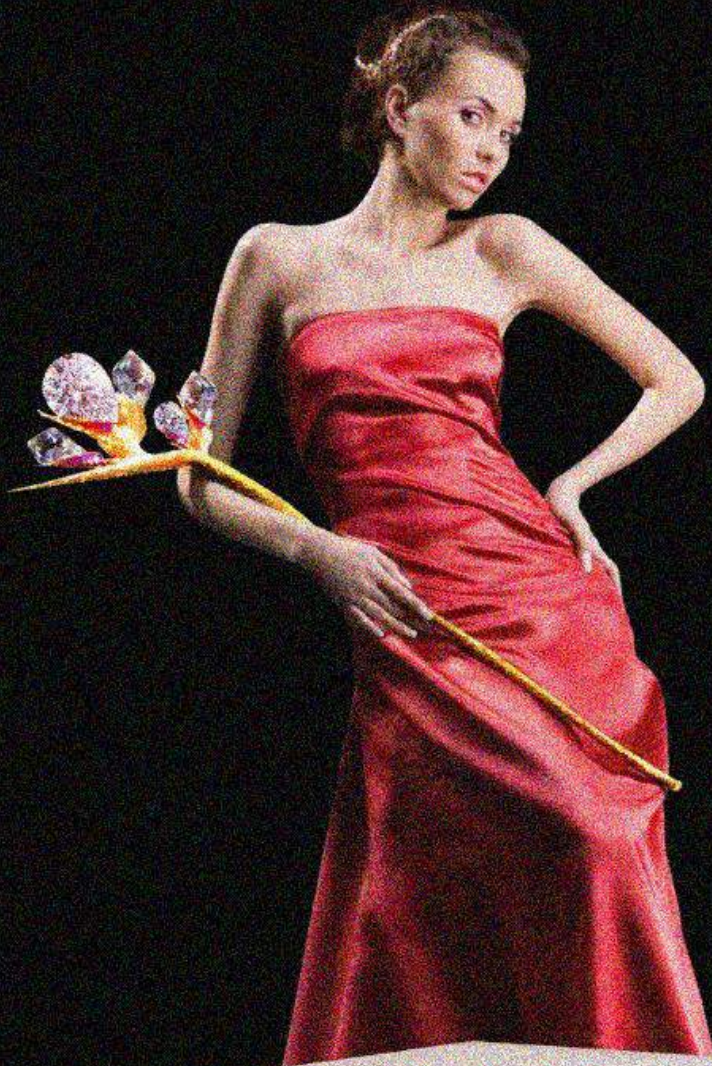

STRONG

◀ SAFES

KP STRONG SAFES

with II, V, VI, VIII safety grade

Strong safes provide the highest level of anti-burglary protection for your cash, securities, documents, and other valuables. Our basic KP safe offers a perfect balance between high quality and an affordable price, which will most certainly bring advantage to your house or office.

- a multi-layer steel construction of the body and the door with a special filling with safety grade V and higher
- a complex bolt system in form of horizontal bolts and a fixed bolt, an additional vertical bolt is available in safety grade II
- thickness of the body 55 mm, thickness of the door 80 mm
- **door opening angle 200°**
- certificate of the Institute of Precision Mechanics in safety grades II, V, VI, VIII
- certified locks:
 - grade A lock (models with safety class II)
 - grade B key lock and grade B code lock (models with safety grade V)
 - grade C key lock and grade C code lock (models with safety grades VI and VIII)



Model	Outer dimensions [mm]			Inner dimensions [mm]			Weight [kg]	Capacity [l]
	H	W	D	H	W	D		
KP II 67	670	500	495	560	390	360	100	79
KP II 100	1000	500	495	890	390	360	130	125
KP II 120	1200	500	495	1090	390	360	153	153
KP II 150	1500	500	495	1390	390	360	193	195

anti-burglary protection level

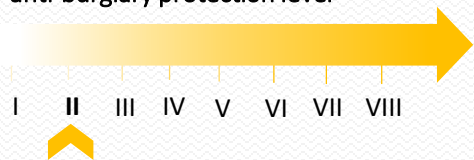

available colours:

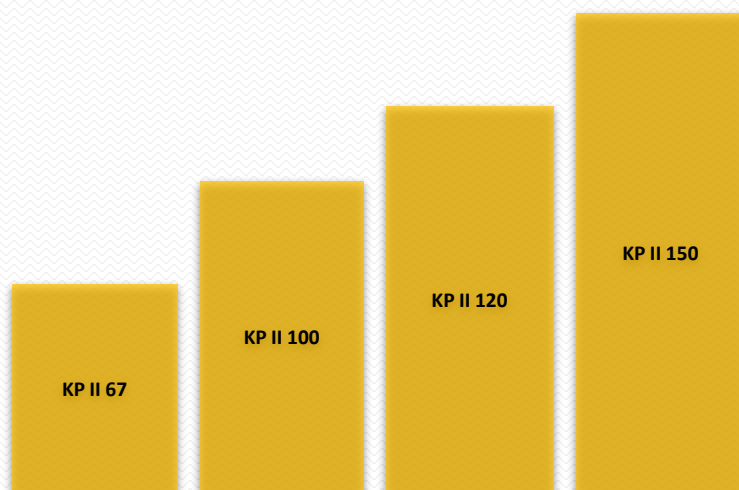

Model	Outer dimensions [mm]			Inner dimensions [mm]			Weight [kg]	Capacity [l]
	H	W	D	H	W	D		
KP V 67	670	680	685	460	500	400	607	92
KP V 100	1000	680	685	790	500	400	785	158
KP V 120	1200	680	685	990	500	400	985	198
KP V 150	1500	680	685	1290	500	400	1195	258

anti-burglary protection level

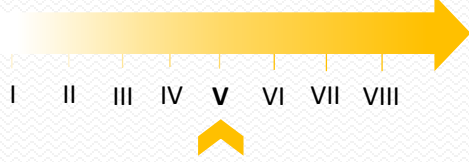

available colours:

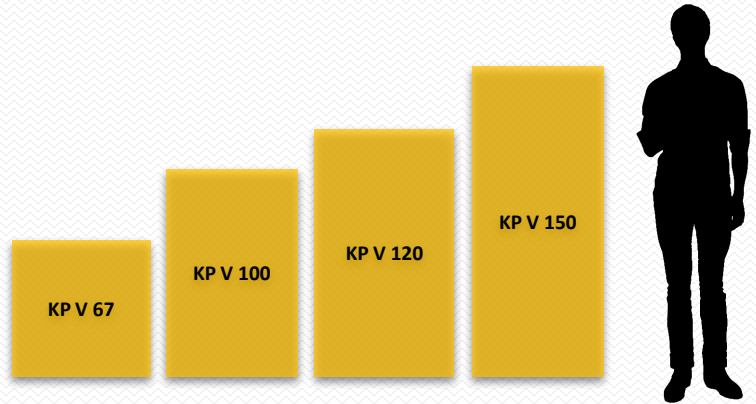

Model	Outer dimensions [mm]			Inner dimensions [mm]			Weight [kg]	Capacity [l]
	H	W	D	H	W	D		
KP VI 67	670	680	685	460	500	400	660	92
KP VI 100	1000	680	685	790	500	400	830	158
KP VI 120	1200	680	685	990	500	400	1047	198
KP VI 150	1500	680	685	1290	500	400	1267	258
KPP VI 120	1200	800	775	990	640	490	1240	310
KPP VI 150	1500	800	775	1290	640	490	1450	405
KPP VI 180	1800	800	775	1690	640	490	1625	530

anti-burglary protection level

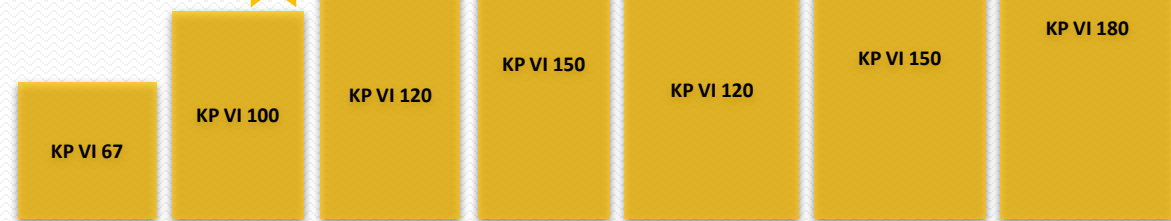
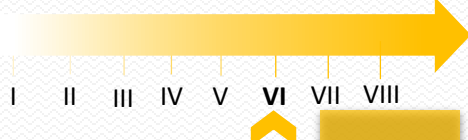

Model	Outer dimensions [mm]			Inner dimensions [mm]			Weight [kg]	Capacity [l]
	H	W	D	H	W	D		
KP VIII 120	1200	780	765	960	530	460	1420	234
KP VIII 150	1500	780	765	1260	530	460	1700	307
KP VIII 180	1800	780	765	1560	530	460	1950	380

anti-burglary protection level

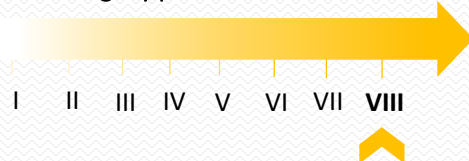

available colours:



KP PRO STRONG SAFES

with II, III, IV safety grade

STANDARD LINE

Thanks to the application of a special composite filling the walls, the KP PRO strong safe is lighter in comparison to other strong safes with similar size. What is more, it has a set of verified anti-burglary solutions that provide the highest level of safety.

- a special, patented structure that successfully prevents from breaking in to the safe by using a grinder
- a four-sided bolting system of the door (vertical, horizontal bolts and a fixed bolt with a diameter of 30 mm)
- drill protection for the bolts
- additional protection of the bolts and the lock
- a fireproof threshold system
- thickness of the body 80 mm, thickness of the door 143 mm
- **door opening angle 200°**
- certificate of the Institute of Precision Mechanics in safety grades II, III, IV
- certified locks:
 - models with safety grade II - grade A key lock
 - models with safety grade III - grade B key lock
 - models with safety grade IV - grade B key lock and grade B code lock



anti-burglary protection level



available colours:



door opening angle 200°

Model	Outer dimensions [mm]			Inner dimensions [mm]			Weight [kg]	Capacity [l]
	H	W	D	H	W	D		
KP PRO II 45 STANDARD	450	580	570	290	420	340	155	41
KP PRO II 62 STANDARD	620	580	570	460	420	340	196	66
KP PRO II 85 STANDARD	850	580	570	690	420	340	255	99
KP PRO II 100 STANDARD	1000	580	570	840	420	340	290	120
KP PRO II 120 STANDARD	1200	580	570	1040	420	340	340	149
KP PRO II 150 STANDARD	1500	580	570	1340	420	340	420	191
KP PRO II 180 STANDARD	1800	580	570	1640	420	340	500	234

Model	Outer dimensions [mm]			Inner dimensions [mm]			Weight [kg]	Capacity [l]
	H	W	D	H	W	D		
KP PRO III 62 STANDARD	620	580	570	460	420	330	290	64
KP PRO III 85 STANDARD	850	580	570	690	420	330	370	96
KP PRO III 100 STANDARD	1000	580	570	840	420	330	420	116
KP PRO III 120 STANDARD	1200	580	570	1040	420	330	490	144
KP PRO III 150 STANDARD	1500	580	570	1340	420	330	600	186
KP PRO III 180 STANDARD	1800	580	570	1640	420	330	710	227

Model	Outer dimensions [mm]			Inner dimensions [mm]			Weight [kg]	Capacity [l]
	H	W	D	H	W	D		
KP PRO IV 62 STANDARD	620	580	570	460	420	330	300	64
KP PRO IV 85 STANDARD	850	580	570	690	420	330	380	96
KP PRO IV 100 STANDARD	1000	580	570	840	420	330	435	116
KP PRO IV 120 STANDARD	1200	580	570	1040	420	330	520	144
KP PRO IV 150 STANDARD	1500	580	570	1340	420	330	660	186
KP PRO IV 180 STANDARD	1800	580	570	1640	420	330	810	227

KP PRO STRONG SAFES

with II, III, IV safety grade

STRONG LINE

The KP PRO strong safe in the STRONG line has been enriched with a stylization package in the form of a decorative signboard made of polished stainless steel and an electronic Combogard lock.

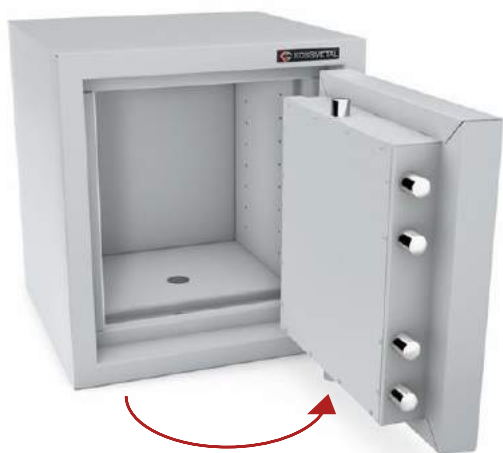

door opening angle 200°

- a special, patented structure that successfully prevents from breaking in to the safe by using a grinder
- a four-sided bolting system of the door (vertical, horizontal bolts and a fixed bolt with a diameter of 30 mm)
- drill protection for the bolts
- additional protection of the bolts and the lock
- a fireproof threshold system
- thickness of the body 80 mm, thickness of the door 143 mm
- **door opening angle 200°**
- certificate of the Institute of Precision Mechanics in safety grades II, III, IV
- certified locks:
 - models with safety grades II and III – Combogard electronic lock
 - models with safety grade IV – Combogard electronic lock and grade B key lock
 - an exterior customization package in form of a decorative signboard made of stainless polished metal sheet

anti-burglary protection level

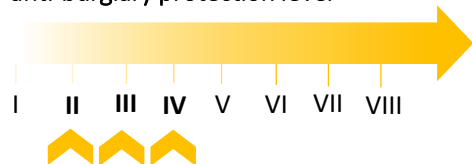

available colours:



Model	Outer dimensions [mm]			Inner dimensions [mm]			Weight [kg]	Capacity [l]
	H	W	D	H	W	D		
KP PRO II 45 STRONG	450	580	570	290	420	340	155	41
KP PRO II 62 STRONG	620	580	570	460	420	340	196	66
KP PRO II 85 STRONG	850	580	570	690	420	340	255	99
KP PRO II 100 STRONG	1000	580	570	840	420	340	290	120
KP PRO II 120 STRONG	1200	580	570	1040	420	340	340	149
KP PRO II 150 STRONG	1500	580	570	1340	420	340	420	191
KP PRO II 180 STRONG	1800	580	570	1640	420	340	500	234

Model	Outer dimensions [mm]			Inner dimensions [mm]			Weight [kg]	Capacity [l]
	H	W	D	H	W	D		
KP PRO III 62 STRONG	620	580	570	460	420	330	290	64
KP PRO III 85 STRONG	850	580	570	690	420	330	370	96
KP PRO III 100 STRONG	1000	580	570	840	420	330	420	116
KP PRO III 120 STRONG	1200	580	570	1040	420	330	490	144
KP PRO III 150 STRONG	1500	580	570	1340	420	330	600	186
KP PRO III 180 STRONG	1800	580	570	1640	420	330	710	227

Model	Outer dimensions [mm]			Inner dimensions [mm]			Weight [kg]	Capacity [l]
	H	W	D	H	W	D		
KP PRO IV 62 STRONG	620	580	570	460	420	330	300	64
KP PRO IV 85 STRONG	850	580	570	690	420	330	380	96
KP PRO IV 100 STRONG	1000	580	570	840	420	330	435	116
KP PRO IV 120 STRONG	1200	580	570	1040	420	330	520	144
KP PRO IV 150 STRONG	1500	580	570	1340	420	330	660	186
KP PRO IV 180 STRONG	1800	580	570	1640	420	330	810	227

KP PRO STRONG SAFES

with II, III, IV safety grade

PREMIUM LINE

KP PRO strong safe in PREMIUM line is an extremely elegant proposal from the Konsmetal company. Thanks to the finishing of the interior with a soft flocked fabric, a three-spoke handle and decorative sign in chrome or gold and a high-gloss paint coating KP PRO takes on a unique character. These safes are equipped with Wittkopp Primor electronic locks.

- a special, patented structure that successfully prevents from breaking in to the safe by using a grinder
- a four-sided bolting system of the door (vertical, horizontal bolts and a fixed bolt with a diameter of 30 mm)
- drill protection for the bolts
- additional protection of the bolts and the lock
- a fireproof threshold system
- thickness of the body 80 mm, thickness of the door 143 mm
- **door opening angle 200°**
- certificate of the Institute of Precision Mechanics in safety grades II, III, IV
- certified locks:
 - models with safety grade II and III – grade B electronic lock
 - models with safety grade IV – grade B electronic lock and grade B key lock
- high-gloss paint coating
- customization package: interior of the safe finished with a soft flocked fabric, three-armed chrome/gold knob, and a decorative chrome/gold signboard

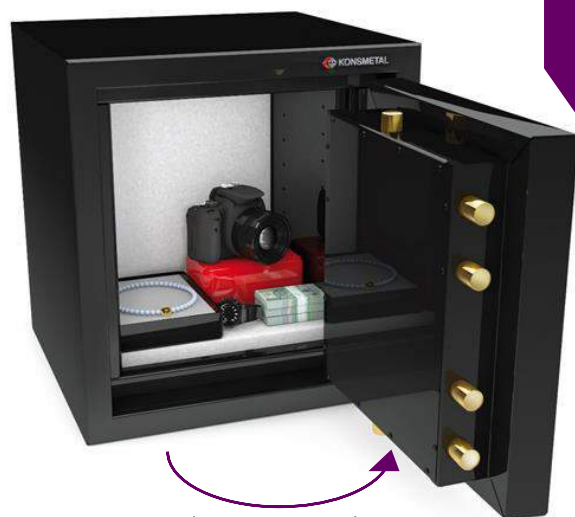

door opening angle 200°

anti-burglary protection level



available colours:



high-gloss paint coating
with any RAL colour

Model	Outer dimensions [mm]			Inner dimensions [mm]			Weight [kg]	Capacity [l]
	H	W	D	H	W	D		
KP PRO II 45 PREMIUM	450	580	570	290	420	340	155	41
KP PRO II 62 PREMIUM	620	580	570	460	420	340	196	66
KP PRO II 85 PREMIUM	850	580	570	690	420	340	255	99
KP PRO II 100 PREMIUM	1000	580	570	840	420	340	290	120
KP PRO II 120 PREMIUM	1200	580	570	1040	420	340	340	149
KP PRO II 150 PREMIUM	1500	580	570	1340	420	340	420	191
KP PRO II 180 PREMIUM	1800	580	570	1640	420	340	500	234

Model	Outer dimensions [mm]			Inner dimensions [mm]			Weight [kg]	Capacity [l]
	H	W	D	H	W	D		
KP PRO III 62 PREMIUM	620	580	570	460	420	330	290	64
KP PRO III 85 PREMIUM	850	580	570	690	420	330	370	96
KP PRO III 100 PREMIUM	1000	580	570	840	420	330	420	116
KP PRO III 120 PREMIUM	1200	580	570	1040	420	330	490	144
KP PRO III 150 PREMIUM	1500	580	570	1340	420	330	600	186
KP PRO III 180 PREMIUM	1800	580	570	1640	420	330	710	227

Model	Outer dimensions [mm]			Inner dimensions [mm]			Weight [kg]	Capacity [l]
	H	W	D	H	W	D		
KP PRO IV 62 PREMIUM	620	580	570	460	420	330	300	64
KP PRO IV 85 PREMIUM	850	580	570	690	420	330	380	96
KP PRO IV 100 PREMIUM	1000	580	570	840	420	330	435	116
KP PRO IV 120 PREMIUM	1200	580	570	1040	420	330	520	144
KP PRO IV 150 PREMIUM	1500	580	570	1340	420	330	660	186
KP PRO IV 180 PREMIUM	1800	580	570	1640	420	330	810	227

KP PRO STRONG SAFES

with II, III, IV safety grade

LUX LINE

The LUX line of our KP PROs in II, III and IV security class is a unique offer not only in terms of its visual, but also safety. The interior was finished with a soft flocked fabric and high-quality furniture insert with drawers, rotating shelves and LED backlighting. A three-armed door handle and a decorative sign in chrome or gold as well as a high-gloss paint coating in any color from the RAL palette complete the whole design. These strong safes are equipped with Wittkopp Primor electronic locks.

- a special, patented structure that successfully prevents from breaking in to the safe by using a grinder
- a four-sided bolting system of the door (vertical, horizontal bolts and a fixed bolt with a diameter of 30 mm)
- drill protection for the bolts
- additional protection of the bolts and the lock
- a fireproof threshold system
- thickness of the body 80 mm, thickness of the door 143 mm
- **door opening angle 200°**
- certificate of the Institute of Precision Mechanics in safety grades II, III, IV
- certified locks:
 - models with safety grade II and III – grade B electronic lock
 - models with safety grade IV – grade B electronic lock and grade B key lock
- high-gloss paint coating
- customization package: interior of the safe finished with a soft flocked fabric, three-armed chrome/gold knob, and a decorative chrome/gold signboard, high-quality furniture insert with drawers, rotating shelves, and LED backlighting



available colours:



high-gloss paint coating
with any RAL colour

anti-burglary protection level



door opening angle 200°

KP PRO STRONG SAFES

with II, III, IV safety grade

Model	Outer dimensions [mm]			Inner dimensions [mm]			Weight [kg]	Capacity [l]
	H	W	D	H	W	D		
KP PRO II 45 LUX	450	580	570	290	420	340	155	41
KP PRO II 62 LUX	620	580	570	460	420	340	196	66
KP PRO II 85 LUX	850	580	570	690	420	340	255	99
KP PRO II 100 LUX	1000	580	570	840	420	340	290	120
KP PRO II 120 LUX	1200	580	570	1040	420	340	340	149
KP PRO II 150 LUX	1500	580	570	1340	420	340	420	191
KP PRO II 180 LUX	1800	580	570	1640	420	340	500	234

Model	Outer dimensions [mm]			Inner dimensions [mm]			Weight [kg]	Capacity [l]
	H	W	D	H	W	D		
KP PRO III 62 LUX	620	580	570	460	420	330	290	64
KP PRO III 85 LUX	850	580	570	690	420	330	370	96
KP PRO III 100 LUX	1000	580	570	840	420	330	420	116
KP PRO III 120 LUX	1200	580	570	1040	420	330	490	144
KP PRO III 150 LUX	1500	580	570	1340	420	330	600	186
KP PRO III 180 LUX	1800	580	570	1640	420	330	710	227

Model	Outer dimensions [mm]			Inner dimensions [mm]			Weight [kg]	Capacity [l]
	H	W	D	H	W	D		
KP PRO IV 62 LUX	620	580	570	460	420	330	300	64
KP PRO IV 85 LUX	850	580	570	690	420	330	380	96
KP PRO IV 100 LUX	1000	580	570	840	420	330	435	116
KP PRO IV 120 LUX	1200	580	570	1040	420	330	520	144
KP PRO IV 150 LUX	1500	580	570	1340	420	330	660	186
KP PRO IV 180 LUX	1800	580	570	1640	420	330	810	227

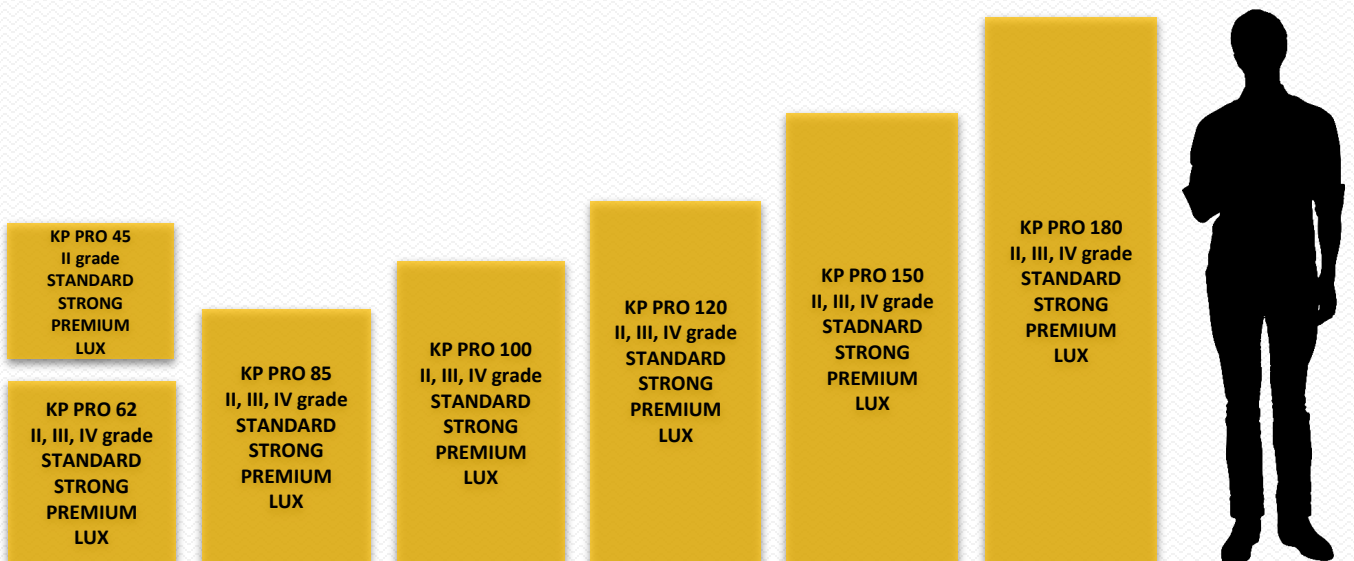

KP ECB-S STRONG SAFES

with II, III safety grade



ECB-S is the most important international entity that certifies products in the security industry. ECB-S certificates constitute a confirmation of the highest protection standards and compliance with instructions of relevant European standards

fireproof thresholds



an intermediate blocking system that protects the lock during an attack on the bolts



door opening angle 200°

a complex bolting system: horizontal bolts, vertical bolts and a fixed bolt

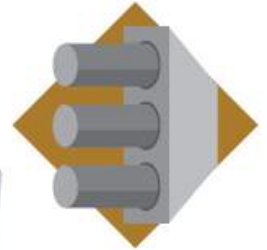

the highest safety standards – lock protection against drilling and thermal attacks

anti-burglary protection level

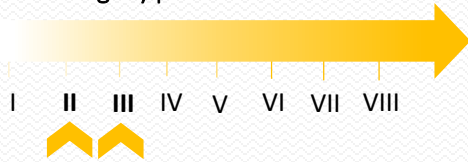

KP ECB-S 45
II grade
STANDARD
STRONG
PREMIUM
LUX

KP ECB-S 62
II, III grade
STANDARD
STRONG
PREMIUM
LUX

KP ECB-S 85
II, III grade
STANDARD
STRONG
PREMIUM
LUX

KP ECB-S 100
II, III grade
STANDARD
STRONG
PREMIUM
LUX

KP ECB-S 120
II, III grade
STANDARD
STRONG
PREMIUM
LUX

KP ECB-S 150
II, III grade
STADNARD
STRONG
PREMIUM
LUX

KP ECB-S 180
II, III grade
STANDARD
STRONG
PREMIUM
LUX



KP ECB-S STRONG SAFES

with II, III safety grade

STANDARD LINE

KP-ECB-S strong safe is a true Mercedes among safes. It ensures the highest-quality, the most efficient technology, and the maximum level of safety and protection. Its highest quality was approved by the European Security Systems Association by awarding it with ECB-S certificate.

- a patented construction of the body and the door made of the highest-quality steel and unique filling
- a complex bolting system securing the door against being opened, even after the hinges have been destroyed.
- a double drill or burn lock protection system
- a system of "Z" fireproof thresholds that protect against high temperatures getting inside
- thickness of the body 80 mm, thickness of the door 150 mm
- **door opening angle 200°**
- certificate of the Institute of Precision Mechanics in safety grades II, III and ECB-S Certificate
- compliance with European standard EN 1143-1
- compliant with requirements of the Regulation of the Polish Ministry of Interior and Administration dated 26.08.2014 on storage, carrying, and registry of guns and ammunition
- locks:
 - grade A key lock for safety grade II
 - grade B key lock for safety grade III



door opening angle 200°

available colours:



Model	Outer dimensions [mm]			Inner dimensions [mm]			Weight [kg]	Capacity [l]
	H	W	D	H	W	D		
KP ECB-S II 45 STANDARD	450	580	570	290	420	330	158	40
KP ECB-S II 62 STANDARD	620	580	570	460	420	330	195	64
KP ECB-S II 85 STANDARD	850	580	570	690	420	330	250	96
KP ECB-S II 100 STANDARD	1000	580	570	840	420	330	285	116
KP ECB-S II 120 STANDARD	1200	580	570	1040	420	330	333	144
KP ECB-S II 150 STANDARD	1500	580	570	1340	420	330	410	186
KP ECB-S II 180 STANDARD	1800	580	570	1640	420	330	490	227

Model	Outer dimensions [mm]			Inner dimensions [mm]			Weight [kg]	Capacity [l]
	H	W	D	H	W	D		
KP ECB-S 62 III STANDARD	620	580	570	460	420	330	305	64
KP ECB-S III 85 STANDARD	850	580	570	690	420	330	395	96
KP ECB-S III 100 STANDARD	1000	580	570	840	420	330	455	116
KP ECB-S III 120 STANDARD	1200	580	570	1040	420	330	535	144
KP ECB-S III 150 STANDARD	1500	580	570	1340	420	330	655	186
KP ECB-S III 180 STANDARD	1800	580	570	1640	420	330	775	227

KP ECB-S STRONG SAFES

with II, III safety grade

STRONG LINE

The KP ECB-S strong safe in the STRONG line has been enriched with a stylization package in the form of a decorative signboard made of polished stainless steel and an electronic Combogard lock.

- a patented construction of the body and the door made of the highest-quality steel and unique filling
- a complex bolting system securing the door against being opened, even after the hinges have been destroyed.
- a double drill or burn lock protection system
- a system of "Z" fireproof thresholds that protect against high temperatures getting inside
- thickness of the body 80 mm, thickness of the door 150 mm
- **door opening angle 200°**
- certificate of the Institute of Precision Mechanics in safety grades II, III and ECB-S Certificate
- compliance with European standard EN 1143-1
- compliant with requirements of the Regulation of the Polish Ministry of Interior and Administration dated 26.08.2014 on storage, carrying, and registry of guns and ammunition
- **Combogard electronic lock**
- **an exterior customization package in form of a decorative signboard made of stainless polished metal sheet**



available colours:



Model	Outer dimensions [mm]			Inner dimensions [mm]			Weight [kg]	Capacity [l]
	H	W	D	H	W	D		
KP ECB-S II 45 STRONG	450	580	570	290	420	330	158	40
KP ECB-S II 62 STRONG	620	580	570	460	420	330	195	64
KP ECB-S II 85 STRONG	850	580	570	690	420	330	250	96
KP ECB-S II 100 STRONG	1000	580	570	840	420	330	285	116
KP ECB-S II 120 STRONG	1200	580	570	1040	420	330	333	144
KP ECB-S II 150 STRONG	1500	580	570	1340	420	330	410	186
KP ECB-S II 180 STRONG	1800	580	570	1640	420	330	490	227

Model	Outer dimensions [mm]			Inner dimensions [mm]			Weight [kg]	Capacity [l]
	H	W	D	H	W	D		
KP ECB-S III 62 STRONG	620	580	570	460	420	330	305	64
KP ECB-S III 85 STRONG	850	580	570	690	420	330	395	96
KP ECB-S III 100 STRONG	1000	580	570	840	420	330	455	116
KP ECB-S III 120 STRONG	1200	580	570	1040	420	330	535	144
KP ECB-S III 150 STRONG	1500	580	570	1340	420	330	655	186
KP ECB-S III 180 STRONG	1800	580	570	1640	420	330	775	227

KP ECB-S STRONG SAFES

with II, III safety grade

PREMIUM LINE

The PREMIUM line of strong safes with the ECB-S certificate has been enriched with a stylization package, which consists of: the interior of the safe finished with a soft flocked fabric, a three-armed handle and decorative signboard in chrome / gold. A high-gloss paint coating is available in all RAL colors. The PREMIUM line is equipped with the Wittkopp Primor electronic lock.

- a patented construction of the body and the door made of the highest-quality steel and unique filling
- a complex bolting system securing the door against being opened, even after the hinges have been destroyed.
- a double drill or burn lock protection system
- a system of "Z" fireproof thresholds that protect against high temperatures getting inside
- thickness of the body 80 mm, thickness of the door 150 mm
- **door opening angle 200°**
- certificate of the Institute of Precision Mechanics in safety grades II, III and ECB-S Certificate
- compliance with European standard EN 1143-1
- compliant with requirements of the Regulation of the Polish Ministry of Interior and Administration dated 26.08.2014 on storage, carrying, and registry of guns and ammunition
- **grade B electronic lock**
- **high-gloss paint coating**
- **customization package: interior of the safe finished with a soft flocked fabric, three-armed chrome/gold knob, and a decorative chrome/gold signboard**



available colours:  high-gloss paint coating with any RAL colour

Model	Outer dimensions [mm]			Inner dimensions [mm]			Weight [kg]	Capacity [l]
	H	W	D	H	W	D		
KP ECB-S II 45 PREMIUM	450	580	570	290	420	330	158	40
KP ECB-S II 62 PREMIUM	620	580	570	460	420	330	195	64
KP ECB-S II 85 PREMIUM	850	580	570	690	420	330	250	96
KP ECB-S II 100 PREMIUM	1000	580	570	840	420	330	285	116
KP ECB-S II 120 PREMIUM	1200	580	570	1040	420	330	333	144
KP ECB-S II 150 PREMIUM	1500	580	570	1340	420	330	410	186
KP ECB-S II 180 PREMIUM	1800	580	570	1640	420	330	490	227

Model	Outer dimensions [mm]			Inner dimensions [mm]			Weight [kg]	Capacity [l]
	H	W	D	H	W	D		
KP ECB-S III 62 PREMIUM	620	580	570	460	420	330	305	64
KP ECB-S III 85 PREMIUM	850	580	570	690	420	330	395	96
KP ECB-S III 100 PREMIUM	1000	580	570	840	420	330	455	116
KP ECB-S III 120 PREMIUM	1200	580	570	1040	420	330	535	144
KP ECB-S III 150 PREMIUM	1500	580	570	1340	420	330	655	186
KP ECB-S III 180 PREMIUM	1800	580	570	1640	420	330	775	227

KP ECB-S STRONG SAFES

with II, III safety grade

ECB-S strong safes in the LUX line are unique products that are tailored to the individual needs of each client. They stand out with a stylization package in the form of interior covered with flocked fabric, a three-spoke handle and a decorative signboard in chrome or gold, rotating shelves, LED backlight and high-gloss paint coating in any color from the RAL palette. It's the highest quality, the most effective technology and the maximum level of security and protection.

- a patented construction of the body and the door made of the highest-quality steel and unique filling
- a complex bolting system securing the door against being opened, even after the hinges have been destroyed.
- a double drill or burn lock protection system
- a system of "Z" fireproof thresholds that protect against high temperatures getting inside
- thickness of the body 80 mm, thickness of the door 150 mm
- **door opening angle 200°**
- Certificate of the Institute of Precision Mechanics in safety grades II, III and ECB-S Certificate
- compliance with European standard EN 1143-1
- compliant with requirements of the Regulation of the Polish Ministry of Interior and Administration dated 26.08.2014 on storage, carrying, and registry of guns and ammunition
- **grade B electronic lock**
- **high-gloss paint coating**
- **customization package: interior of the safe finished with a soft flocked fabric, three-armed chrome/gold knob, and a decorative chrome/gold signboard, high-quality furniture insert with drawers, rotating shelves, and LED backlighting**



door opening angle 200°

available colours:  high-gloss paint coating with any RAL colour

Model	Outer dimensions [mm]			Inner dimensions [mm]			Weight [kg]	Capacity [l]
	H	W	D	H	W	D		
KP ECB-S II 45 LUX	450	580	570	290	420	330	183	40
KP ECB-S II 62 LUX	620	580	570	460	420	330	225	64
KP ECB-S II 85 LUX	850	580	570	690	420	330	288	96
KP ECB-S II 100 LUX	1000	580	570	840	420	330	330	116
KP ECB-S II 120 LUX	1200	580	570	1040	420	330	385	144
KP ECB-S II 150 LUX	1500	580	570	1340	420	330	472	186
KP ECB-S II 180 LUX	1800	580	570	1640	420	330	562	227

Model	Outer dimensions [mm]			Inner dimensions [mm]			Weight [kg]	Capacity [l]
	H	W	D	H	W	D		
KP ECB-S III 62 LUX	620	580	570	460	420	330	335	64
KP ECB-S III 85 LUX	850	580	570	690	420	330	433	96
KP ECB-S III 100 LUX	1000	580	570	840	420	330	500	116
KP ECB-S III 120 LUX	1200	580	570	1040	420	330	587	144
KP ECB-S III 150 LUX	1500	580	570	1340	420	330	717	186
KP ECB-S III 180 LUX	1800	580	570	1640	420	330	847	227



CABINETS FOR DOCUMENTS

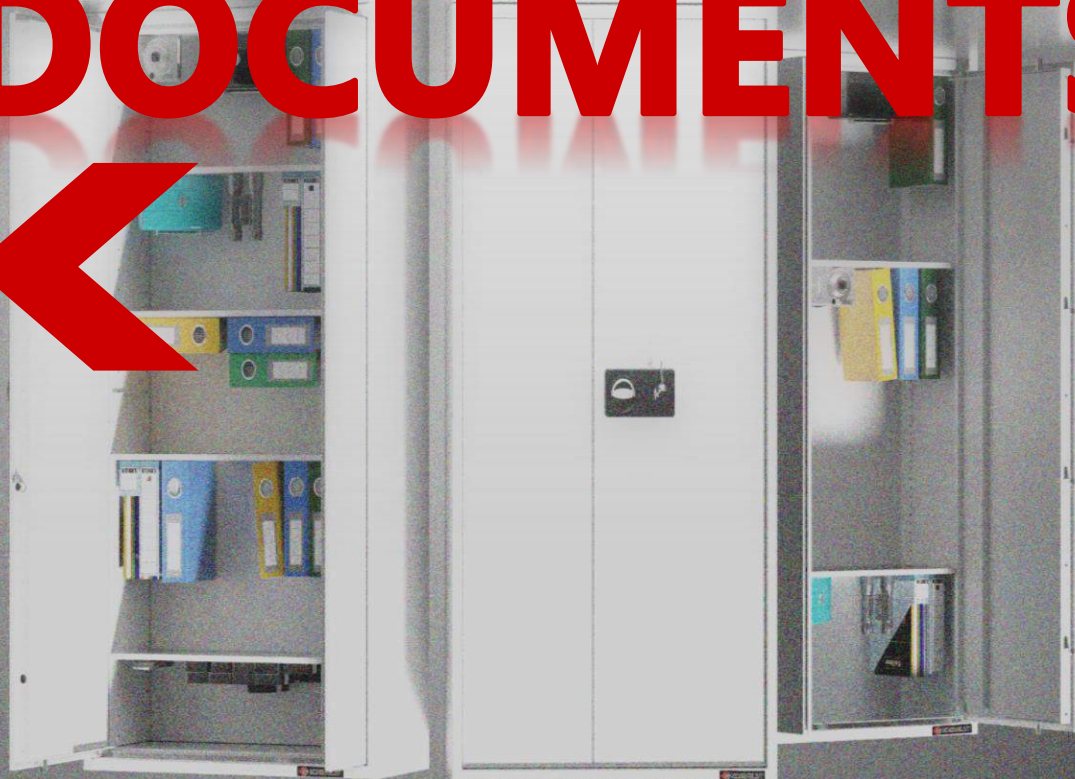

CABINETS FOR DOCUMENTS

with no safety grade

Security cabinets compliant with the basic requirements concerning storage of documents.

- the body and the door made of steel metal plate sheet with thickness of 0.8 mm
- a four-sided bolting system of the door (vertical, horizontal bolts and a fixed bolt with a diameter of 6 mm)
- Eurolock with a handle
- door opening angle of 120 that enables seamless usage
- optional double-door extensions

available colours:

light
gray RAL
7035



Model	Outer dimensions [mm]			Inner dimensions [mm]			Weight [kg]	Capacity [l]
	H	W	D	H	W	D		
TWO-DOOR CABINETS								
MS2 D199	1990	1200	400	1915	1185	362	82	821
MS2 199	1990	1000	400	1915	985	362	72	683
MS2 M199	1990	800	400	1915	785	362	62	544
TWO-DOOR HEIGHT EXTENSIONS								
MS2D	470	1200	400	395	1195	362	23	171
MS2	470	1000	400	395	995	362	20	142
MS2M	470	800	400	395	795	362	17	114

MS CABINETS FOR DOCUMENTS

with safety grades A, B, C

SAFETY GRADE A

MS steel security cabinets are a perfect balance between good quality and price. They are the most popular solution in public institutions, archives and offices.

- for storage of classified documents marked as "confidential"
- available in a single and double-door version
- construction of the body and the door of a steel metal plate sheet with thickness of 1 mm
- a **four-sided bolting system of the door** (vertical, horizontal bolts and a fixed bolt with a diameter of 12 mm)
- IMP certificate according to Ordinances no. 46 and 57 of the Ministry of Defense
- IMP certificate according to the Council of Ministers Regulation dated 29.05.2012 – Type 1
- compliant with the Council of Ministers Regulation dated 01.06.2010 on organization and functioning of secret offices
- grade A key lock



Model	Outer dimensions [mm]			Inner dimensions [mm]			Weight [kg]	Capacity [l]
	H	W	D	H	W	D		
MS1/A 150	1500	700	500	1495	685	440	64	451
MS1M/A 150	1500	700	400	1495	685	340	54	348
MS1M/A 190	1900	700	400	1895	685	340	63	441
MS2M/A 190	1900	1000	400	1895	985	340	78	635
MS2/A 4/2	1900	1000	400	1895	985	340	88	635

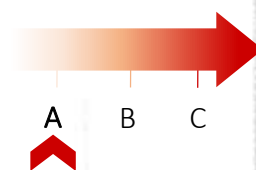

available colours:

light gray RAL 7035

MS CABINETS FOR DOCUMENTS

with safety grades A, B, C

SAFETY GRADE B

MS steel security cabinets are a perfect balance between good quality and price. They are the most popular solution in public institutions, archives and offices.

- for storage of classified documents marked as "secret"
- available in a single and double-door version
- sturdy construction of the body and the door of a steel metal plate sheet with thickness of 3 mm
- a four-sided bolting system of the door (vertical, horizontal bolts and a fixed bolt with a diameter of 20 mm)
- lock protection against attacks, e.g. drilling or radiological examination
- IMP certificate according to Ordinances no. 46 and 57 of the Ministry of Defense
- IMP certificate according to the Council of Ministers Regulation dated 29.05.2012 – Type 2
- compliant with the Council of Ministers Regulation dated 01.06.2010 on organization and functioning of secret offices
- **grade B key lock**



Model	Outer dimensions [mm]			Inner dimensions [mm]			Weight [kg]	Capacity [l]
	H	W	D	H	W	D		
MS1/B 150	1500	700	500	1495	684	415	130	424
MS1/B 185	1850	700	500	1844	684	415	155	523
MS2/B 185	1850	1000	500	1844	984	415	200	753

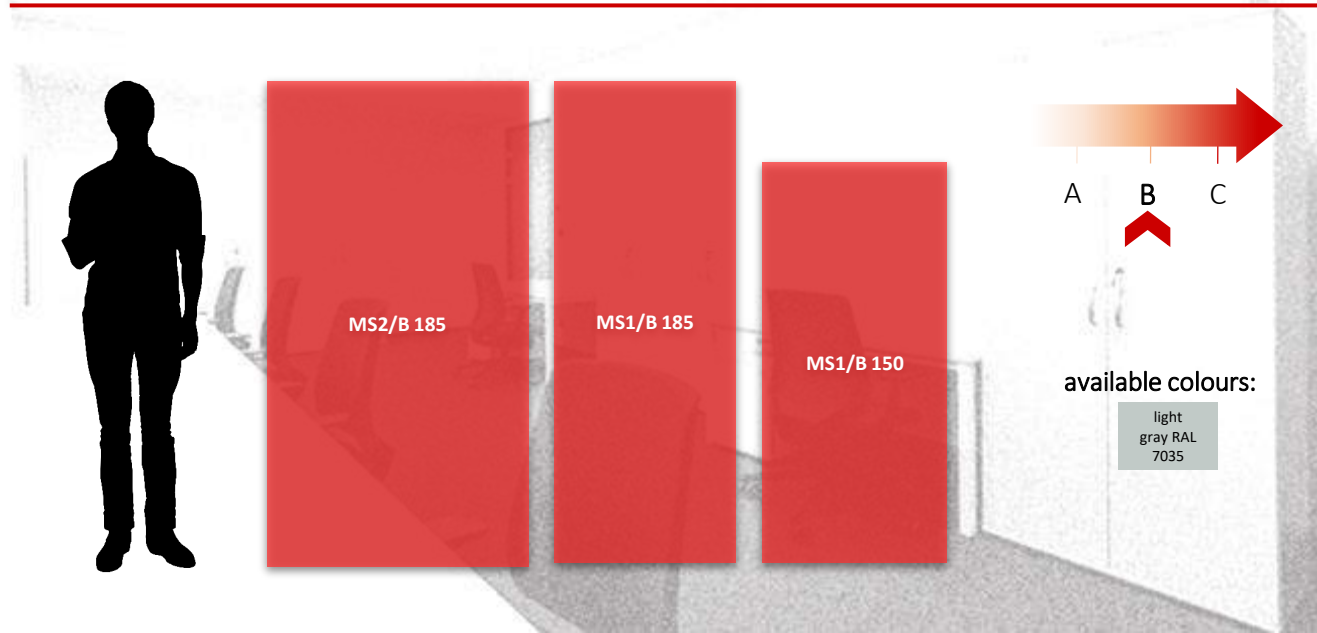

MS CABINETS FOR DOCUMENTS

with safety grades A, B, C

SAFETY GRADE C

MS steel security cabinets are a perfect balance between good quality and price. They are the most popular solution in public institutions, archives and offices.

- for storage of classified documents marked as "top secret"
- available in a single and double-door version
- a four-sided bolting system of the door (vertical, horizontal bolts and a fixed bolt with a diameter of 20 mm)
- a two-layer construction - the outer body is made of steel metal plate sheet with thickness of 3 mm, the inner body is made of steel metal plate with thickness of 1.5 mm
- doors of two layers of steel metal plate sheet with thickness of 3 mm and 1.5 mm
- lock protection against attacks, e.g. drilling or radiological examination
- IMP certificate according to Ordinances no. 46 and 57 of the Ministry of Defense
- IMP certificate according to the Council of Ministers Regulation dated 29.05.2012 – Type 2
- IMP certificate in grade C according to the Council of Ministers Regulation dated 23.01.2014
- compliant with the Council of Ministers Regulation dated 01.06.2010 on organization and functioning of secret offices
- grade B key lock and grade B mechanical code lock



Model	Outer dimensions [mm]			Inner dimensions [mm]			Weight [kg]	Capacity [l]
	H	W	D	H	W	D		
MS1/C 150	1500	700	500	1300	900	375	180	439
MS1/C 185	1850	700	500	1750	900	375	210	591
MS2/C 185	1850	1000	500	1750	900	375	270	591



SD CABINETS FOR DOCUMENTS

with safety grades S1, S2, 0

SAFETY GRADE S1

SD metal security cabinets are the strongest product among cabinets for documents. They are made of the best materials and their construction features the use of advanced technology.

SD SECURITY CABINETS WITH SAFETY GRADE S1 (Type 2)

- for storage of classified documents marked as "secret"
- available in a single and double-door version
- a four-sided bolting system of the door (vertical, horizontal bolts and a fixed bolt with a diameter of 20 mm)
- sturdy construction of the body and the door of a steel metal plate sheet with thickness of 3 mm
- IMP certificate according to standard PN-EN 14450
- IMP certificate for type 2 according to the Council of Ministers Regulation dated 29.05.2012
- possibility of storing guns and ammunition in accordance with the Regulation of the Polish Ministry of Interior and Administration dated 21.10.2011
- grade A key lock



Model	Outer dimensions [mm]			Inner dimensions [mm]			Weight [kg]	Capacity [l]
	H	W	D	H	W	D		
SD1/S1 150S	1500	600	440	1494	584	358	115	312
SD1/S1 185S	1850	600	440	1844	584	358	135	386
SD2/S1 185D	1850	1000	440	1844	984	358	190	650

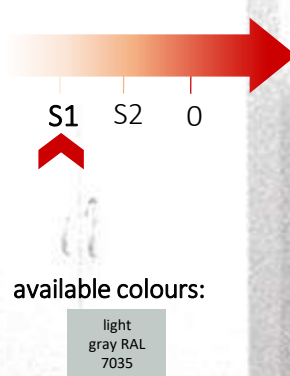

SD CABINETS FOR DOCUMENTS

with safety grades S1, S2, 0

SAFETY GRADE S2

SD metal security cabinets are the strongest product among cabinets for documents. They are made of the best materials and their construction features the use of advanced technology.

SD SECURITY CABINETS WITH SAFETY GRADE S2 (Type 3)

- for storage of classified documents marked as "top secret"
- available in a single and double-door version
- a four-sided bolting system of the door (vertical, horizontal bolts and a fixed bolt with a diameter of 20 mm)
- sturdy construction of the body and the door of a steel metal plate sheet with thickness of 3 mm
- the body and the door reinforced with an additional metal plate sheet with thickness of 1.5 mm
- lock protection against attacks, e.g. drilling or radiological examination
- IMP certificate according to standard PN-EN 14450
- IMP certificate for type 3 according to the Council of Ministers Regulation dated 29.05.2012
- possibility of storing guns and ammunition in accordance with the Regulation of the Polish Ministry of Interior and Administration dated 21.10.2011
- **grade B code lock**



Model	Outer dimensions [mm]			Inner dimensions [mm]			Weight [kg]	Capacity [l]
	H	W	D	H	W	D		
SD1/S2 150S	1500	600	440	1400	500	316	150	221
SD1/S2 185S	1850	600	440	1750	500	316	180	277
SD2/S2 185D	1850	1000	440	1750	900	316	225	498



available colours:

light gray RAL 7035

SD CABINETS FOR DOCUMENTS

with safety grades S1, S2, 0

SAFETY GRADE 0

SD metal security cabinets are the strongest product among cabinets for documents. They are made of the best materials and their construction features the use of advanced technology.

SD SECURITY CABINETS WITH SAFETY GRADE 0 (Type 4)

- for storage of classified documents marked as **"top secret"**
- available in a single and double-door version
- a four-sided bolting system of the door (vertical, horizontal bolts and a fixed bolt with a diameter of 20 mm)
- a three-layer construction – the outer body is made of steel metal plate sheet with thickness of 3 mm, the inner bodies are made of steel metal sheets with thickness of 1.5 mm and 1 mm
- door made of steel metal plate sheet with thickness of 8 mm
- lock protection against attacks, e.g. drilling or radiological examination
- IMP certificate according to standard PN-EN 1143-1
- IMP certificate for type 4 according to the Council of Ministers Regulation dated 29.05.2012
- possibility of storing guns and ammunition in accordance with the Regulation of the Polish Ministry of Interior and Administration dated 21.10.2011
- **two grade B mechanical code locks**



Model	Outer dimensions [mm]			Inner dimensions [mm]			Weight [kg]	Capacity [l]
	H	W	D	H	W	D		
SD1/0 150S	1500	600	460	1400	500	300	248	210
SD1/0 185S	1850	600	460	1750	500	300	300	263
SD2/0 185D	1850	1000	460	1750	900	300	448	473

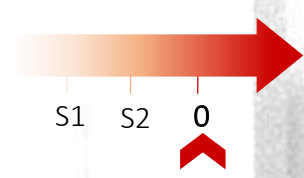

available colours:

light gray RAL 7035



BUSINESS SOLUTIONS

KOLIBER DEPOSIT DROP SAFES

without safety grade

If you are looking for a safe with the option allowing deposits of larger amounts of cash or cash-out documents, the Koliber deposit drop safe will be a good solution for your needs. That safe will allow you to quickly deposit an excess of cash, both in a store as well as in an office, without opening the safe.

- an anti-robbery safety system in form of:
 - a time delay when opening the electronic lock, which significantly decreases the risk of emptying the cashbox in case of a robbery
 - a silent lock alarm, which, when connected to the security system, always informs the security agency that there has been an attempt of robbing the cashbox or an incorrect code was used
- the body made of a strong metal sheet with high resistance to being forced
- a complex bolting system with strong bolts of 20 mm in diameter, with an additional cover of the whole system, including the lock
- deposit drop slots on the side or the top
- the possibility of making deposits of cash and documents with maximum size of 24x155 mm through the side drop slot and 12x155 through the top
- a comb protecting the deposited packages from being extracted



Model	Outer dimensions [mm]			Inner dimensions [mm]			Weight [kg]	Capacity [l]
	H	W	D	H	W	D		

KOLIBER SAFES WITH A TOP DEPOSIT DROP SLOT, WITHOUT SAFETY GRADE

Koliber WG 20	200	310	200	190	294	140	13	8
Koliber WG 35	350	310	280	340	294	220	22	22
Koliber WG 45 Laptop 15"	450	400	370	440	384	310	35	52

KOLIBER SAFES WITH A SIDE DEPOSIT DROP SLOT, WITHOUT SAFETY GRADE

Koliber W 45 Laptop 15"	450	400	370	440	384	310	35	52
-------------------------	-----	-----	-----	-----	-----	-----	----	----

available colours:

light gray
RAL 7035

black
RAL 9005

Koliber
W45
Laptop
15"

Koliber
WG45
Laptop
15"

Koliber
WG35

Koliber
WG20



KOLIBER DEPOSIT DROP SAFES

with S1 safety grade

If you are looking for a stronger protection for the cash deposited in the safe, including the possibility of insuring it, the Koliber deposit drop safe with safety grade S1 will be your perfect solution.



- deposit drop slots secured with an additional key lock
- drop slot can be mounted on the side or back of the safe
- a reinforced door slab with a cover of the bolts and the lock
- sturdy bolts with a diameter of 20 mm that have a special drill protection of the bolts
- thickness of the body 3 mm, thickness of the door 51 mm
- **an anti-robbery safety system in form of:**
 - a time delay when opening the electronic lock, which significantly decreases the risk of emptying the cashbox in case of a robbery
 - a silent lock alarm, which, when connected to the security system, always informs the security agency that there has been an attempt of robbing the cashbox or an incorrect code was used
- certificate of the Institute of Precision Mechanics in safety grade S1
- compliance with the standard regarding storage of valuables under supervision PN-EN 14450 grade S1

Model	Outer dimensions [mm]			Inner dimensions [mm]			Weight [kg]	Capacity [l]
	H	W	D	H	W	D		
Koliber W45 Laptop 15"	450	400	370	440	384	310	41	52
Koliber W45 Laptop 17"	450	490	370	440	474	310	46	65
Koliber W62 Laptop 17"	620	490	370	610	474	310	56	90



available colours:

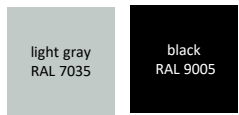

ML DEPOSIT DROP SAFES

with S1 safety grade



Are you looking for a high-quality product for your commercial facility? Do you prefer the best solutions? ML deposit drop safe is the best choice in the group of single-layer safes.



- an anti-burglary self-locking system that increases the resistance of the safe to burglary
- an anti-burglary frame that efficiently protects against crowbars
- a four-sided bolting system of the door (vertical, horizontal bolts and a fixed bolt) with a diameter of 20 mm
- the drop slot and drawer secured with a key lock
- a comb protecting the deposited packages from being extracted
- thickness of the body 3 mm, thickness of the door 83 mm
- certificate of the Institute of Precision Mechanics in safety grade S1
- compliance with the standard regarding storage of valuables under supervision PN-EN 14450 grade S1

Model	Outer dimensions [mm]			Inner dimensions [mm]			Weight [kg]	Capacity [l]
	H	W	D	H	W	D		
ML SAFES WITH A DEPOSIT DROP SLOT (SIDE OR BACK)								
MLW 45/S1	450	400	460	444	335	350	53	52
MLW 67/S1	670	400	460	664	335	350	66	78
ML SAFES WITH DEPOSIT DROP DRAWER								
ML+WSX 45/S1	450	400	460	345	335	350	56	40
ML+WSX 67/S1	670	400	460	565	335	350	69	66

available colours:

light gray
RAL 7035

black
RAL 9005



Kolibr
W62
Laptop 17"

Kolibr
W45
Laptop 17"

Kolibr
W45
Laptop
15"



KP STRONG SAFES WITH A DEPOSIT DRUM



with II safety grade

Among deposit drop safes, strong safes provide the highest quality of anti-burglary protection. Thanks to their special construction, they significantly increase the safety of deposits. A strong safe with a deposit drum gives the possibility of making deposits and storing cash 24/7 without opening the safe and using a key. It means that only authorized persons have the access to money and deposits.

- a four-sided bolting system of the door (vertical, horizontal bolts and a fixed bolt with a diameter of 30 mm)
- a double drill or burn lock protection system
- an intermediate blocking system that protects the lock during an attack on the bolts
- a drum deposit drop that automates the process of cash deposits
- a special protection against extraction of deposits
- a fireproof threshold system
- certificate of the Institute of Precision Mechanics in safety grade S1
- compliance with the standard regarding storage of valuables PN-EN 1143-2 grade N II



Model	Outer dimensions [mm]			Inner dimensions [mm]			Weight	Capacity
	H	W	D	H	W	D	[kg]	[l]
KP 100+ WBX3	1000	580	570	500	420	330	289	69
KP 120+ WBX3	1200	580	570	700	420	330	333	97
KP 150+ WBX3	1500	580	570	1000	420	330	414	139



available colours:

light gray
RAL 7035

black
RAL 9005

SW DEPOSIT DROP CASHBOXES

without safety grade



The product is intended both for cashiers who must remove the excess of money from the cash register, as well as for company owners who would like to secure their cash. The deposit drop cartridge allows quick deposit of banknotes (without the need of having the code or the key) and their secure storage.

- possibility of depositing cash, accounting bills, and checks
- possibility of installation on the desk or fixing to the floor
- the deposit drop slot is protected against unauthorized extraction of deposits
- insert of 300-400 banknotes
- an anti-robbery safety system in form of:
 - a time delay when opening the electronic lock, which significantly decreases the risk of emptying the cashbox in case of a robbery
 - a silent lock alarm, which, when connected to the security system, always informs the security agency that there has been an attempt of robbing the cashbox or an incorrect code was used



available colours:

light gray
RAL 7035

black
RAL 9005

Model	Outer dimensions [mm]			Dimensions of drop slot [mm]	Weight [kg]	Capacity [l]
	H	W	D			
SW-EM*	330	142	246	10 x 87	14	4
SW-K**	330	142	246	10 x 87	14	4

* Cashbox with A-grade electronic lock

** Cashbox with A-grade key lock

SL CASHIER SAFES

with I safety grade



A perfect solution for cashier stands in all the places where there is a need for securing the cash with which the cashiers work when handling customers. The safe is divided into two parts locked independently: a drawer for the ongoing operation and the deposit part. Each cashier may settle their own take without the need of involving the manager or the company owner.

- a drawer with an insert part for coins and banknotes and a deposit drop slot, which one may use to deposit cash and documents (model SL 67+)
- a special cartridge for deposits and a compartment for a binder (model SLP 67+)
- a fixed shelf in the deposit part
- a complex construction of the door made of the highest-quality metal plate sheet with high resistance to attacks
- **an anti-robbery safety system in form of:**
 - a time delay when opening the electronic lock, which significantly decreases the risk of emptying the cashbox in case of a robbery
 - a silent lock alarm, which, when connected to the security system, always informs the security agency that there has been an attempt of robbing the cashbox or an incorrect code was used
- compliance with the standard regarding storage of valuables under supervision PN-EN 1143-1, grade I
- grade A key lock

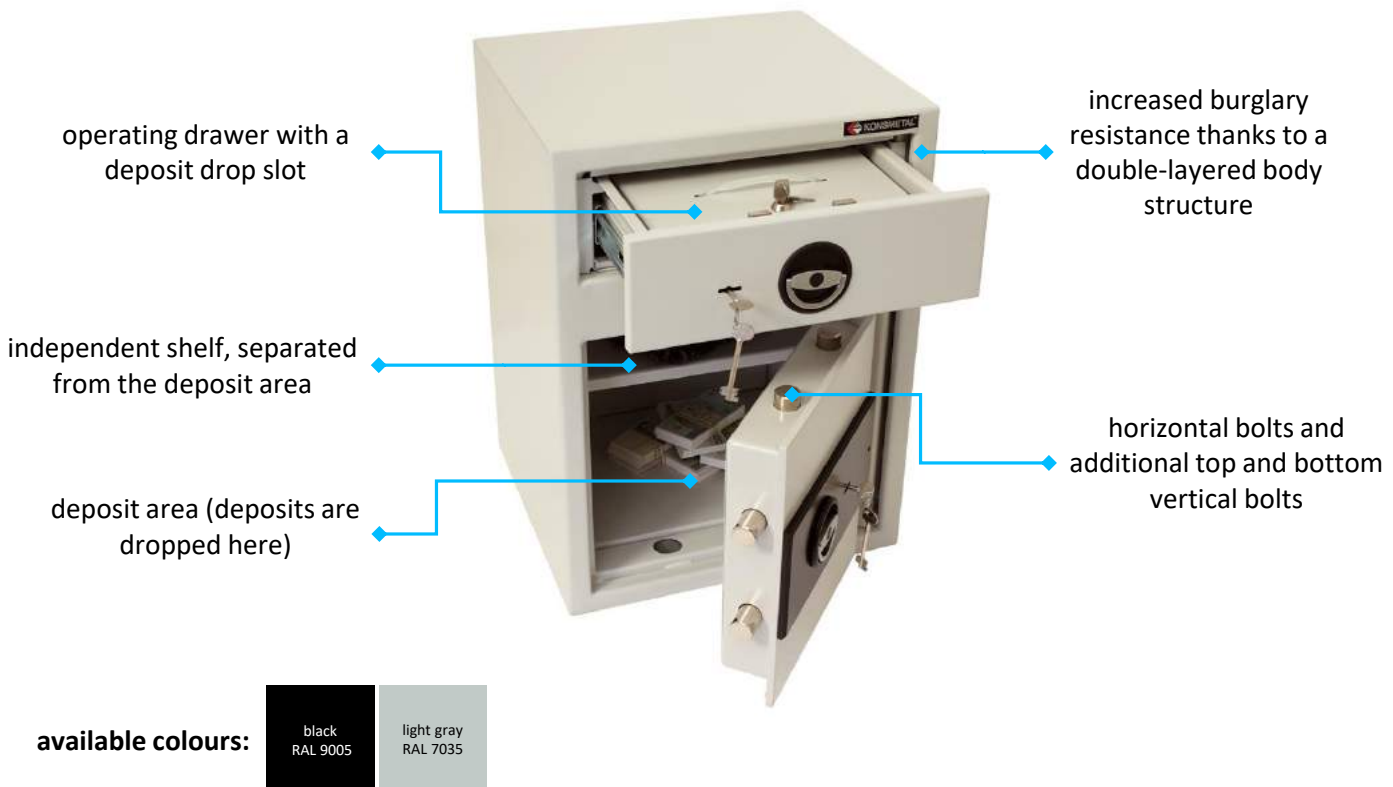

available colours:

black
RAL 9005

light gray
RAL 7035

Model	Outer dimensions [mm]			Drawer dimensions [mm]			Weight [kg]	Capacity [l]
	H	W	D	H	W	D		
SL67+	670	490	460	120	363	197	150	25
SLP67+	670	490	640	120	363	363	182	18

MULTI-SAFES XS

with safety grades S2, I



Safes intended for being used at cashier stands in modern bank facilities. They secure the cash cashiers work with when handling customers. Safes may be divided into 3, 4, or 6 drawers. Each cashier may settle their own take without the need of involving the manager.

- a drawer control system that consists of:
 - electronic control of access to the drawers
 - automatic cashier lock (during the work of one cashier, another cashier has no possibility of accessing the device)
 - an indicator in case of improperly closed drawers
 - protection of each shelf drawer against taking out the content through a different drawer
- a mechanical night lock
- a possibility of integration with external software and databases
- event log – up to 5,000 entries stored in the device or an unlimited storage in the application
- **an anti-robbery safety system in form of:**
 - a time delay when opening the electronic lock, which significantly decreases the risk of emptying the cashbox in case of a robbery
 - a silent lock alarm, which, when connected to the security system, always informs the security agency that there has been an attempt of robbing the cashbox or an incorrect code was used
- certificate of the Institute of Precision Mechanics in safety grades S2 and I
- compliance with standards regarding storage of valuables: PN-EN 14450 grade S2 and PN-EN 1143-1 grade I



Model	Outer dimensions [mm]			Weight [kg]		Drawer volume [l]
	H	W	D	Grade S2	Grade I	
3-drawer Multi-safe	655	520	540	130	160	43
Drawer type	Outer dimensions [mm]			Drawer equipment - available as an option		
	H	W	D			
Operating	83	372	350	case for coins and bills		
Deposit	83	372	350	-		
Insert	205	372	304	drop slot + case for coins and bills		
4-drawer Multi-safe	655	520	540	135	165	40
Drawer type	Outer dimensions [mm]			Drawer equipment - available as an option		
	H	W	D			
Operating	83	372	350	case for coins and bills		
Deposit x2	83	372	350	-		
Insert	83	372	304	drop slot + case for coins and bills		
6-drawer Multi-safe	655	520	540	145	175	36
Drawer type	Outer dimensions [mm]			Drawer equipment - available as an option		
	H	W	D			
Operating	83	372	350	case for coins and bills		
Deposit x4	83	372	350	-		
Insert	83	372	304	drop slot + case for coins and bills		

ELECTRONIC DEPOSIT STRONG SAFES



grades N II, N IV – N VI

Electronic deposit strong safes mean round-the-clock intuitive and easy operated self-depositing of valuables. User identification is performed by means of a Mifare proximity card and/or a PIN code.

- the value of the deposited packet can be declared directly at the device
- confirmation receipt for the user can be printed or recorded on the Mifare proximity card
- device available in three versions:
 - stand-alone deposit strong safe
 - built in wall-mounted deposit strong safe with the input unit door and receiving unit door on the same side
 - built in wall-mounted deposit strong safe with a drop chute and the input unit door on the opposite side to receiving unit door
- the drop compartment has a drum opened with a lever, an electronic unit with an illuminated display and keyboard, and a selection of additional equipment
- event log
- infrared barriers
- emergency power supply



ADDITIONAL EQUIPMENT

- weather- and vandal-resistant door
- drop chute
- drum or drop chute lighting
- printer
- B&W, colour or HD camera
- barcode reader
- Mifare proximity card reader
- door can be adapted to enable connection to the access control system
- additional lock: electronic or combination
- remotely controlled locks
- lock casing in outer doors
- one time code system
- alarm sensors:
 - sensors of partial door closure
 - sensors of bolts position in the deposit compartment
 - „fishing” sensor
 - overflow sensor
 - paper sensor in the printer
- seismic sensor
- mounting anchors



drum with a
lever



 **STRONGROOMS**

Special room designed for a long-term storage of cash in banks and other financial institutions. Built of special cast or modular elements enabling quick assembly and disassembly of the premises.

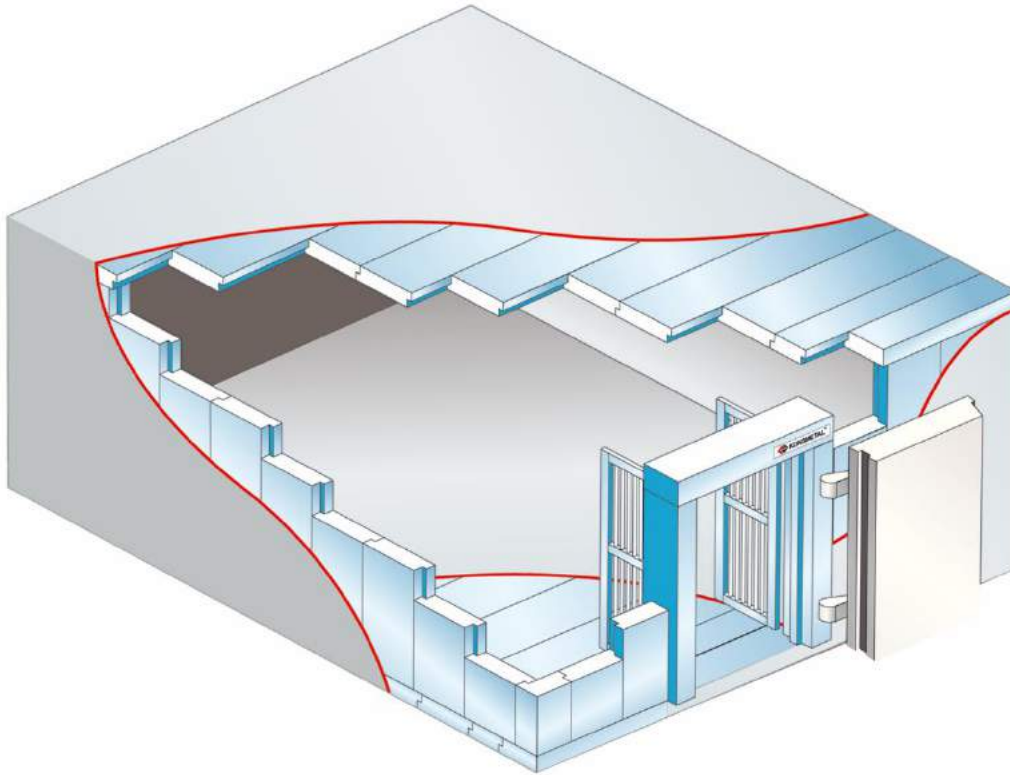

VAULTS:

- certificate for storing valuables in accordance with the EN 1143-1 standard, grades IV, V, VI, IX, X, XI
- existing vault facilities can be provided with additional reinforcement and re-qualified to higher grades.
- high burglary resistance with additional anti-burglary reinforcement.
- using special cast applied to vault walls is certified by the Institute of Precision Mechanics in Warsaw, for grades V and VI.
- emergency hatch can be installed in the vault walls (recommended).
- size can be customized to the user's needs.

STRONGROOM DOORS:

- installed in modular and cast vaults.
- filled with special steel reinforcement and a mixture of concrete with selected additives, suitable for specific protection grades.
- from grade IX, equipped with a single or double gate (standard option).
- selection of the opening direction of the main door and grate.
- equipped with locks of the highest protection level.
- lock breaking and point attack protection (standard option).
- alarm installation output.

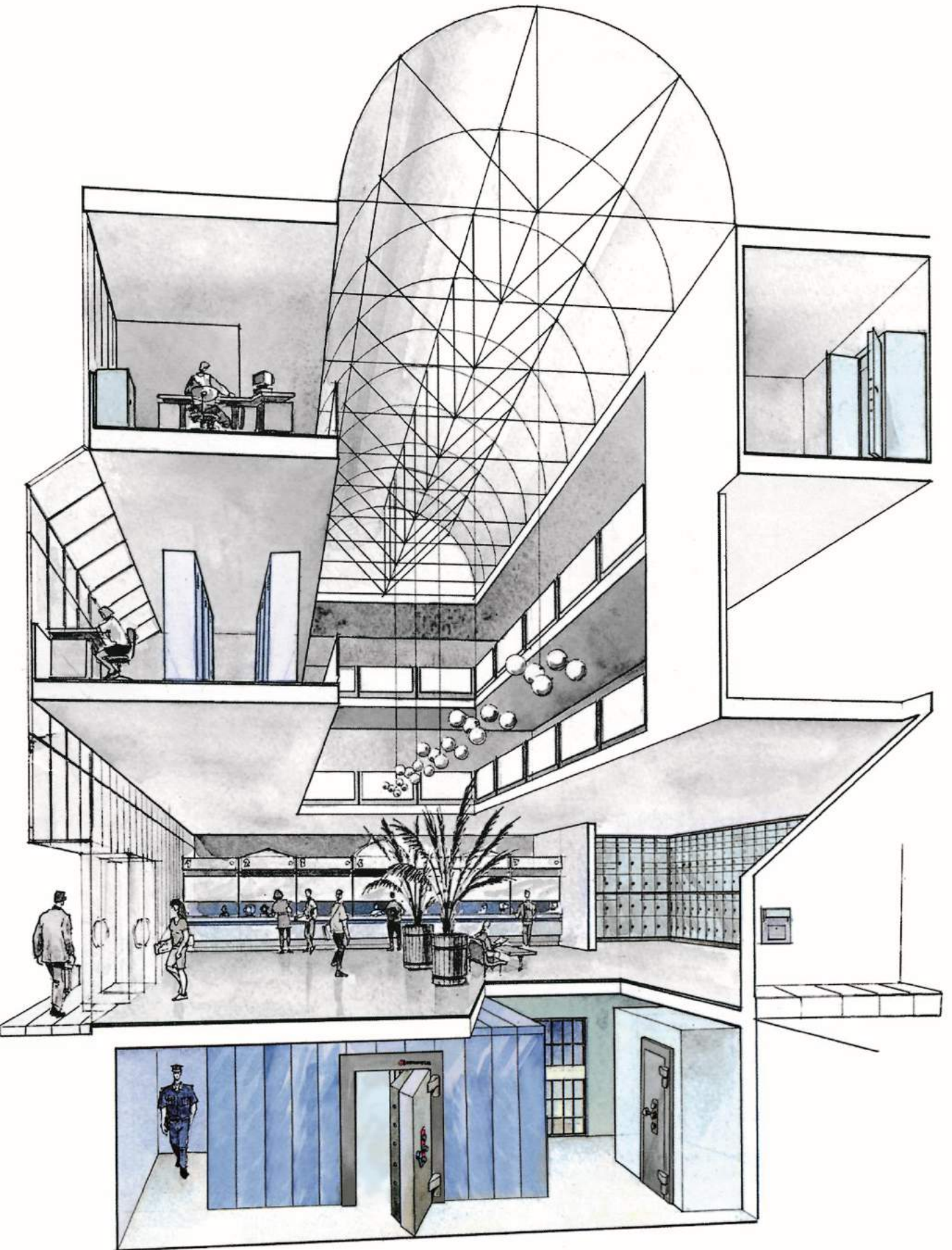

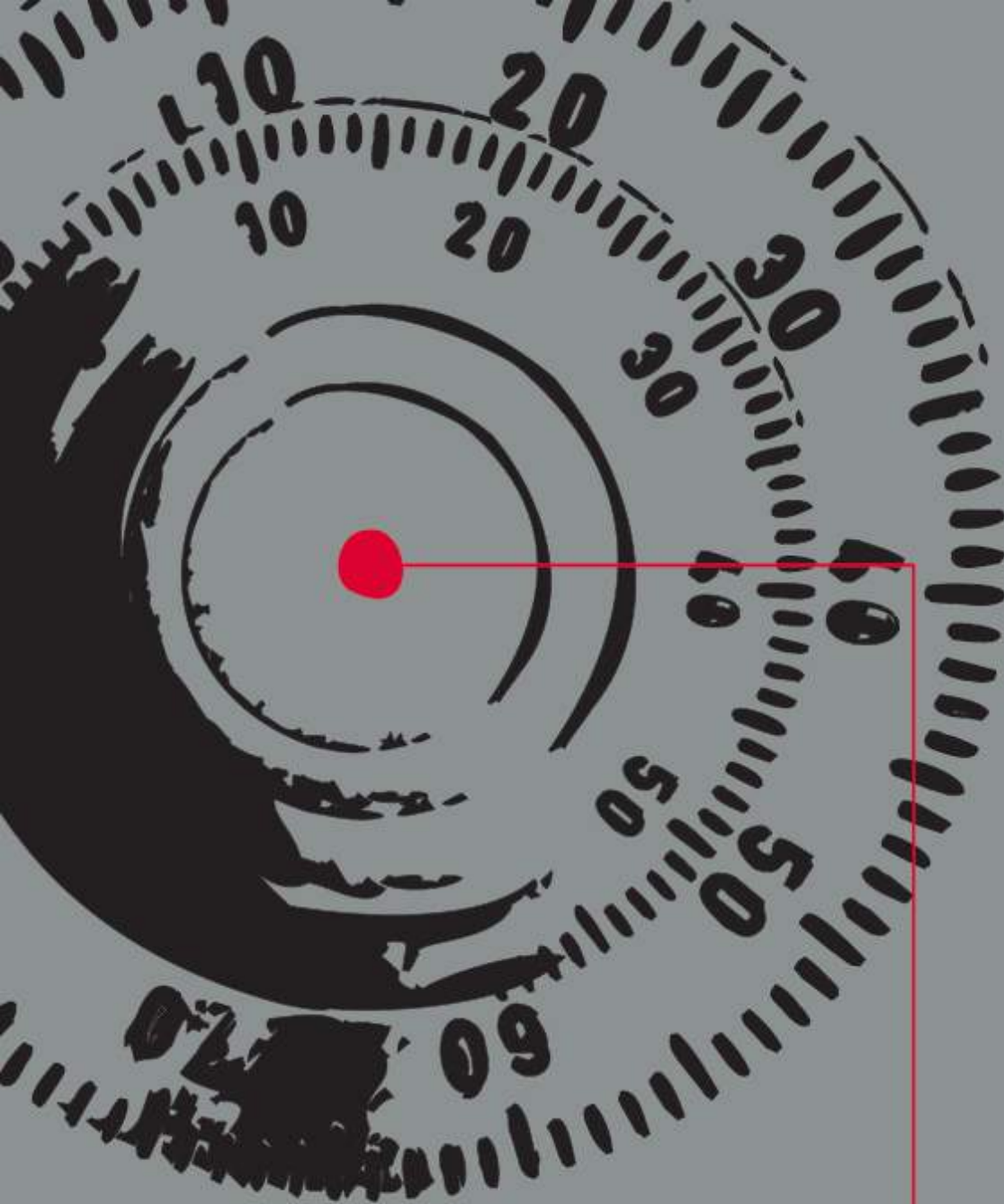

Joanna Sak

E-mail: j.sak@konsmetal.pl

Tel.: +48 512 050 072

www.konsmetal.pl



KONSMETAL®